



CDPS-4S2HSS

4×2 SDI to HDMI Seamless Splitter with PIP



Operation Manual



DISCLAIMERS

The information in this manual has been carefully checked and is believed to be accurate. Cypress Technology assumes no responsibility for any infringements of patents or other rights of third parties which may result from its use.

Cypress Technology assumes no responsibility for any inaccuracies that may be contained in this document. Cypress also makes no commitment to update or to keep current the information contained in this document.

Cypress Technology reserves the right to make improvements to this document and/or product at any time and without notice.

COPYRIGHT NOTICE

No part of this document may be reproduced, transmitted, transcribed, stored in a retrieval system, or any of its part translated into any language or computer file, in any form or by any means—electronic, mechanical, magnetic, optical, chemical, manual, or otherwise—without express written permission and consent from Cypress Technology.

© Copyright 2011 by Cypress Technology.

All Rights Reserved.

Version 1.1 August 2011

TRADEMARK ACKNOWLEDGMENTS

All products or service names mentioned in this document may be trademarks of the companies with which they are associated.





SAFETY PRECAUTIONS

Please read all instructions before attempting to unpack, install or operate this equipment and before connecting the power supply.

Please keep the following in mind as you unpack and install this equipment:

- Always follow basic safety precautions to reduce the risk of fire, electrical shock and injury to persons.
- To prevent fire or shock hazard, do not expose the unit to rain, moisture or install this product near water.
- Never spill liquid of any kind on or into this product.
- Never push an object of any kind into this product through any openings or empty slots in the unit, as you may damage parts inside the unit.
- Do not attach the power supply cabling to building surfaces.
- Use only the supplied power supply unit (PSU). Do not use the PSU if it is damaged.
- Do not allow anything to rest on the power cabling or allow any weight to be placed upon it or any person walk on it.
- To protect the unit from overheating, do not block any vents or openings in the unit housing that provide ventilation and allow for sufficient space for air to circulate around the unit.

REVISION HISTORY

VERSION NO.	DATE (DD/MM/YY)	SUMMARY OF CHANGE
VR0	21/08/15	Preliminary release



CONTENTS

1. Introduction.....	1
2. Applications.....	1
3. Package Contents	1
4. System Requirements.....	1
5. Features.....	2
6. Operation Controls and Functions.....	3
6.1 Front Panel.....	3
6.2 Rear Panel.....	4
6.3 Remote Control.....	5
6.4 OSD Menu	6
6.5 RS-232 Protocol.....	16
6.6 RS-232 and Telnet Commands	17
6.7 Software Application.....	24
6.8 Telnet Control	25
6.9 WebGUI Control.....	27
6.9.1 Image Adjust	27
6.9.2 Output Resolution	27
6.9.3 Window Setup	28
6.9.4 OSD Settings	29
6.9.5 Window Convert.....	29
6.9.6 Chromakey Setup.....	30
6.9.7 Ethernet.....	30
7. Connection Diagram	31
8. Specifications	32
9. Acronyms.....	33





1. INTRODUCTION

The 4 by 2 SDI to HDMI Seamless Quad PIP Splitter is a high performance, high speed zooming/shrinking system that can be easily configure and control for quad or picture-in-picture video processing. Allowing 4 different SDI input sources to be freely selected and arranged on to HDMI displays with total of 8 different types of settings. Supporting resolution up to WUXGA@60RB, 1080p and audio up to 8CH with sampling rate 48kHz for both inputs and outputs. Screen setting hot keys, OSD, RS-232 and Telnet allows instant control and switching on the output displays.

2. APPLICATIONS

- Broadcasting room and control
- Surveillance room and control
- Public advertisement and control
- SDI signal extending

3. PACKAGE CONTENTS

- 1×4 by 2 SDI to HDMI Seamless Splitter
- 1×Remote Control (CR-124)
- 1×12V/3A DC Power Adaptor
- 1× Rack Ear Sets
- Operation Manual

4. SYSTEM REQUIREMENTS

Input source equipment such as SNG camera or SDI signal, PC/Laptop or RS-232 control devices and output HD TV/monitors with connection cables.

5. FEATURES

- Supports SD-SDI (SMPTE 259M-C, at bitrates of 270 Mbit/s) input signals up to 250M
- Supports HD-SDI (SMPTE 292M, at bitrates of 1.485Gbit/s and 1.485/1.001 Gbit/s) input signals up to 200M
- Supports 3G-SDI (SMPTE 424M/425M-AB, at bitrates of 2.970 Gbit/s and 2.970/1.001 Gbit/s) input signals up to 100M
- HDMI output compatible with DVI
- Combine four SDI inputs single into HDMI and output on to two synchronize HD screen
- Seamless switching between channels and windows
- Zoom and Shrink 4CH input image and or to overlay them
- Supports PIP, POP and multi-windows display
- Supports OSD, RS-232 Remote and on-panel controls
- Fade-In-Out, Chromakey, Mirror and Rotation (90° left & right and 180° up & down) functions
- 8 Screen setting hot keys and extra 4 customized favorite screen setting
- Easily to adjust size, position and setting of 4 input images via WebGUI, only drag and few clicks can achieve output display format setting



6. OPERATION CONTROLS AND FUNCTIONS

6.1 Front Panel

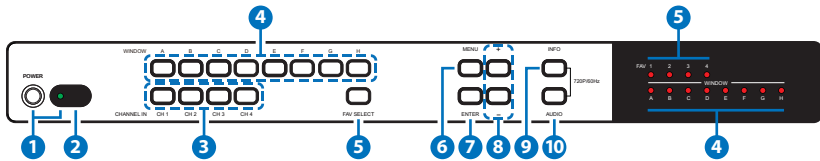

- 1 POWER Button & LED:** Press this button to power on the device and the LED will illuminate in green or set it to standby mode and the LED will illuminate in Red.
- 2 IR Window:** Accept IR signal from the device's remote control included in the package only.
- 3 CHANNEL IN 1~4:** Press these buttons to rotate SDI 1~4 input source on each channel to be display on screens. All channels can select the same input or each channel a different input.
- 4 WINDOW A~H & LEDs:** Press these hot keys to select the screen setting where A~D are display a full screen of each channel and E~H are a different combination of a full screen setting with all 4 channels.

Windows A~D's channel input selection is corresponding to channel input no. 1~4. That is, to change window A's input channel must press channel input 1's button. Channel input 2~4's button will not activate under window A's selection. Windows E~H's size are adjustable through the OSD menu setting and only window G & H is PIP(Picture in Picture) where E & F are POP (Picture out Of picture) settings.

Under window E~H when the size setting is overlapping one another, channel display sequence is CH4>CH3>CH2 >CH1. That is, CH4 will cover CH3 and CH3 will cover CH2 and so on. Under some display the borderline may have interference, adjusting display's motion setting may resolve the interference issue.

- 5 FAV SELECT & LEDs:** Press this button to recall the favor setting from 1~4 and the LED will illuminate accordingly.
- 6 MENU:** Press this button to bring up the OSD menu on screen.

- 7 **ENTER:** Press this button to enter into MENU selection and confirm the selection.
- 8 **-/+ Buttons:** Press these buttons to scroll down/up the OSD selections.
- 9 **INFO:** Press this button to bring up the information section from the OSD menu.
- 10 **AUDIO:** Press this button to select audio channel.
Note: Press the 'INFO & AUDIO' buttons together to switch output resolution to 720p@60Hz instantly.

6.2 Rear Panel

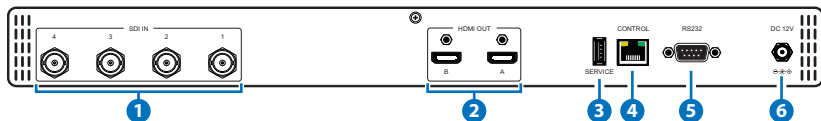

- 1 **SDI IN:** Connect with source equipment such as SNG camera or SDI signal devices.
- 2 **HDMI OUT:** Connect with HD TV/monitor for output image display.
- 3 **SERVICE:** This slot is reserved for factory use only.
- 4 **CONTROL:** Connect from PC/Laptop for Telnet control with RJ-45 cable.
- 5 **RS-232:** Connect from PC/Laptop/RS-232 equipped device with D-Sub 9pin cable for RS-232 command sending.
- 6 **DC 12V:** Plug the 12V DC power supply into the unit and connect the adaptor to an AC outlet.

6.3 Remote Control

- 1 **Power:** Press this button to switch on the device or press it again to set it to standby mode.
- 2 **Info:** Press this button to show system information.
- 3 **Input CH 1~4:** Press these buttons to rotate SDI 1~4 input source on each channel to be display on screen
- 4 **WA~WH:** Press these hot keys to select the screen setting where WA~WD are display a full screen of each channel and WE~WH are a different combination of a full screen setting with all 4 channels.
- 5 **Mute:** Press this button to mute the audio from HDMI output port.
- 6 **▲/▼/▶/◀ & OK Buttons:** Press this buttons to scroll through the OSD selection and press OK to enter and confirm the setting.
- 7 **Menu:** Press this button to enter into the OSD menu.
- 8 **Exit:** Press this button to exit the OSD menu or the OSD settings.
- 9 **Fade-In-Out*:** Press this button to switch on or off the Fade-in-out function.
- 10 **Chromakey*:** Press this button to enter into Chroma function where CH 1 is the background and CH 2 is the top image.
- 11 **Mirror*:** Press this button to display the screen in mirror image.
- 12 **Rotation*:** Press this button to rotate the image 90° left and right or 180° upside down.
- 13 **Audio 1~4:** Press these buttons to select audio from SDI input source 1~4.
- 14 **FAV. 1~4:** Press these buttons to bring up the customized screen settings.

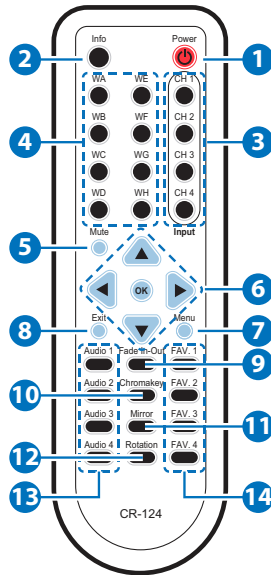

*Note: *Functions only work under Window A to D. The system will force to switch to Window A when operate under Window E~H.*

6.4 OSD Menu

MAIN MENU	1ST LAYER	2ND LAYER	3RD LAYER
I/O Setup	Output Resolution	480p60	
		567p50	
		720p50	
		720p60	
		1080p24	
		1080p25	
		1080p30	
		1080p50	
		1080p60	
		1024x768	
		1280x800	
	1280x1024		
	1366x768		
	1440x900		
	1600x900		
1600x1200			
1920x1200			
	NATIVE¹		
	Menu Back		
OSD Setting	Info Display		On/ Off
	H Offset		0~20 (5)
	V Offset		0~20 (5)
	OSD Timeout		5~50/Off (10)
	Transparent		0~10 (5)
	Menu Back		
Menu Exit			

MAIN MENU	1ST LAYER	2ND LAYER	3RD LAYER
Image Adjust	Brightness Adjust	CH 1	0~100 (50)
		CH 2	0~100 (50)
		CH 3	0~100 (50)
		CH 4	0~100 (50)
		Value Reset	
		Menu Exit	
	Contrast Adjust	CH 1	0~100 (50)
		CH 2	0~100 (50)
		CH 3	0~100 (50)
		CH 4	0~100 (50)
		Value Reset	
		Menu Exit	
	Saturation Adjust	CH 1	0~100 (50)
		CH 2	0~100 (50)
		CH 3	0~100 (50)
		CH 4	0~100 (50)
		Value Reset	
		Menu Exit	
	Picture Reset	CH 1	0~100 (50)
		CH 2	0~100 (50)
		CH 3	0~100 (50)
CH 4		0~100 (50)	
Value Reset			
Menu Exit			
	Menu Exit		

MAIN MENU	1ST LAYER	2ND LAYER	3RD LAYER	
Window Setup	Channel 1 Select	Size	CH1 Wxxx Hxxx	
			Width Unit	
			Width Ten	
			Width Hundred	
			Height Unit	
			Height Ten	
		Position	CH1 Hxxx Vxxx	
			Horizontal Unit	
			Horizontal Ten	
			Horizontal Hundred	
			Vertical Unit	
			Vertical Ten	
		Priority	1~4	
			Image Output	On/Off
			Window Reset	
			Menu Exit	

MAIN MENU	1ST LAYER	2ND LAYER	3RD LAYER	
Window Setup	Channel 2 Select	Size	CH1 Wxxx Hxxx	
			Width Unit	
			Width Ten	
			Width Hundred	
			Height Unit	
			Height Ten	
		Position	CH1 Hxxx Vxxx	
			Horizontal Unit	
			Horizontal Ten	
			Horizontal Hundred	
			Vertical Unit	
			Vertical Ten	
		Priority	1~4	
			Image Output	On/Off
			Window Reset	
			Menu Exit	

MAIN MENU	1ST LAYER	2ND LAYER	3RD LAYER	
Window Setup	Channel 3 Select	Size	CH1 Wxxx Hxxx	
			Width Unit	
			Width Ten	
			Width Hundred	
			Height Unit	
			Height Ten	
			Height Hundred	
			Position	CH1 Hxxx Vxxx
				Horizontal Unit
		Horizontal Ten		
		Horizontal Hundred		
		Vertical Unit		
		Vertical Ten		
		Vertical Hundred		
		Priority	1~4	
		Image Output	On/Off	
		Window Reset		
		Menu Exit		

MAIN MENU	1ST LAYER	2ND LAYER	3RD LAYER
Window Setup	Channel 4 Select	Size	CH1 Wxxx Hxxx
			Width Unit
			Width Ten
			Width Hundred
			Height Unit
			Height Ten
		Height Hundred	
		Position	CH1 Hxxx Vxxx
			Horizontal Unit
			Horizontal Ten
			Horizontal Hundred
			Vertical Unit
			Vertical Ten
		Vertical Hundred	
	Priority	1~4	
	Image Output	On/Off	
	Window Reset		
	Menu Exit		
	Label ²	VIDEO 1	
		VIDEO 2	
		VIDEO 3	
		VIDEO 4	
		Menu Exit	
	Favors Store	FAV 1 Store	Yes/ No
		FAV 2 Store	Yes/ No
		FAV 3 Store	Yes/ No
		FAV 4 Store	Yes/ No
Menu Exit			
Menu Exit			

MAIN MENU	1ST LAYER	2ND LAYER	3RD LAYER
Window Convert	Channel 1 Convert	Mirror	On/ Off
		Fade In-Out	On/ Off
		Rotation	R90/L90/Up-Side Down180/ Off
		Window Reset	
		Menu Exit	
	Channel 2 Convert	Mirror	On/ Off
		Fade In-Out	On/ Off
		Rotation	R90/L90/Up-Side Down180/ Off
		Window Reset	
		Menu Exit	
	Channel 3 Convert	Mirror	On/ Off
		Fade In-Out	On/ Off
		Rotation	R90/L90/Up-Side Down180/ Off
		Window Reset	
		Menu Exit	
	Channel 4 Convert	Mirror	On/ Off
		Fade In-Out	On/ Off
		Rotation	R90/L90/Up-Side Down180/ Off
		Window Reset	
		Menu Exit	

MAIN MENU	1ST LAYER	2ND LAYER	3RD LAYER
Chromakey Setup³	User 1	Minimum For Y 16~240	
		Maximum For Y 16~240	
		Minimum For Cb 16~240	
		Maximum For Cb 16~240	
		Minimum For Cr 16~240	
		Maximum For Cr 16~240	
		Chromakey On/ Off	
	User 2	Minimum For Y 16~240	
		Maximum For Y 16~240	
		Minimum For Cb 16~240	
		Maximum For Cb 16~240	
		Minimum For Cr 16~240	
		Maximum For Cr 16~240	
		Chromakey On/ Off	
	White	Minimum For Y 234~235	
		Maximum For Y 234~235	
		Minimum For Cb 127~129	
		Maximum For Cb 127~129	
		Minimum For Cr 127~129	
		Maximum For Cr 127~129	
		Chromakey On/ Off	
	Yellow	Minimum For Y 218~220	
		Maximum For Y 218~220	
		Minimum For Cb 16~18	
Maximum For Cb 16~18			
Minimum For Cr 137~139			
Maximum For Cr 137~139			
Switch On/ Off			

MAIN MENU	1ST LAYER	2ND LAYER	3RD LAYER
Chromakey Setup³ (Cont.)	Cyan	Minimum For Y 187~189	
		Maximum For Y 187~189	
		Minimum For Cb 152~154	
		Maximum For Cb 152~154	
		Minimum For Cr 16~18	
		Maximum For Cr 16~18	
		Chromakey On/ Off	
	Green	Minimum For Y 171~173	
		Maximum For Y 171~173	
		Minimum For Cb 40~42	
		Maximum For Cb 40~42	
		Minimum For Cr 25~27	
		Maximum For Cr 25~27	
		Chromakey On/ Off	
	Magenta	Minimum For Y 77~79	
		Maximum For Y 77~79	
		Minimum For Cb 213~215	
		Maximum For Cb 213~215	
		Minimum For Cr 228~230	
		Maximum For Cr 228~230	
		Chromakey On/ Off	
	Red	Minimum For Y 61~63	
		Maximum For Y 61~63	
		Minimum For Cb 101~103	
		Maximum For Cb 101~103	
		Minimum For Cr 239~240	
		Maximum For Cr 239~240	
		Chromakey On/ Off	

MAIN MENU	1ST LAYER	2ND LAYER	3RD LAYER
Chromakey Setup³ (Cont.)	Blue	Minimum For Y 30~32	
		Maximum For Y 30~32	
		Minimum For Cb 239~240	
		Maximum For Cb 239~240	
		Minimum For Cr 116~118	
		Maximum For Cr 116~118	
		Chromakey On/ Off	
	Black	Minimum For Y 16~17	
		Maximum For Y 16~17	
		Minimum For Cb 127~129	
		Maximum For Cb 127~129	
		Minimum For Cr 127~129	
		Maximum For Cr 127~129	
		Chromakey On/ Off	
Exit			
Ethernet Setup	IP Mode	Static /DHCP	
	Time Out	10~~60min/ Off	
	RE-Link	Yes/ No	
	Exit		
Sys Reset	Yes/No		
Information	Screen Resolution		
	F/W Version		
	F/W Upgrade		
	Exit		
Menu Exit			

Note:

1. When in 'NATIVE' resolution, the unit will read the EDID settings of the display connected to HDMI OUT A.
2. Naming character up to 9 characters.
3. Chromakey Setup only works when CH 1 and CH 2 are selected. CH 1 is the background and CH 2 is the top layer to be overlaid. The RGB setting is for the CH2 video where the minimum setting figures cannot be greater than the maximum figures and the maximum figures cannot be lower than the minimum setting figures.
4. Figures in **BOLD** are default settings.

6.5 RS-232 Protocol

SPLITTER	
Pin	Assignment
1	NC
2	TX
3	RX
4	NC
5	GND
6	NC
7	NC
8	NC
9	NC

►
 ◀

REMOTE CONTROLLER	
Pin	Assignment
1	NC
2	RX
3	TX
4	NC
5	GND
6	NC
7	NC
8	NC
9	NC

Baud Rate: 115200bps
 Data bit: 8 bits
 Parity: None
 Flow Control: None
 Stop Bit: 1

6.6 RS-232 and Telnet Commands

COMMAND	DESCRIPTION	PARAMETER
?	<i>Prints all available commands to the screen</i>	
HELP	<i>Prints all available commands to the screen</i>	
SPOW 0/1	<i>Set the unit power on/off</i>	0=Off 1=On
RPOW	<i>Show current power state</i>	
SRES 0~18	<i>Set output resolution</i>	0=480p@60Hz 1=576p@50Hz 2=720p@50Hz 3=720p@60Hz 4=1080p@24Hz 5=1080p@25Hz 6=1080p@30Hz 7=1080p@50Hz 8=1080p@60Hz 9=1024x768@60Hz 10=1280x800@60Hz 11=1280x1024@60Hz 12=1366x768@60Hz 13=1440x900@60Hz 14=1600x900@60Hz 15=1600x1200@60Hz 16=1680x1050@60Hz 17=1920x1200@60Hz 18=Native
RRES	<i>Show current output resolution</i>	
SIOSDD 0/1	<i>Enable/disable on-screen information display</i>	0=Off 1=On
RIOSDD	<i>Show information OSD display current state</i>	
SOSDH 0~20	<i>Set OSD horizontal position</i>	0~20

COMMAND	DESCRIPTION	PARAMETER
ROSDH	Show OSD horizontal position current	
SOSDV 0~20	Set OSD vertical position	0~20
ROSDV	Show OSD vertical position current	
SOSDT 0/5~50	Set OSD display time	0 =Off/5~50 (second)
ROSDT	Show OSD display current time	
SOSDG 0~10	Set OSD transparent value	0~10
ROSDG	Show OSD transparent current value	
SBRI X Y	Set brightness value for input channel	X=0/1~4, 0=All channels, 1~4=Channel 1~4 Y=0~100
RBRI 0~4	Show brightness current value	0=All channels, 1~4=Channel 1~4
SCON X Y	Set contrast value for input channel	X=0/1~4, 0=All channels, 1~4=Channel 1~4 Y=0~100
RCON 0~4	Show contrast current value	0=All channels, 1~4=Channel 1~4
SSAT X Y	Set saturation value for input channel	X=0/1~4, 0=All channels, 1~4=Channel 1~4 Y=0~100
RSAT 0~4	Show saturation current value	0=All channels, 1~4=Channel 1~4
SPIRE	Reset brightness, contrast, saturation all channel value to default	
SIMRE 1~3	Reset brightness or contrast or saturation value to default	1=Brightness 2=Contrast 3=Saturation

COMMAND	DESCRIPTION	PARAMETER
SHSIZE X Y	<i>Set image horizontal size**</i>	X=Channel 1~4 Y= 0~1920
RHSIZE 1~4	<i>Show image horizontal size current value**</i>	1~4=Channel 1~4
SVSIZE X Y	<i>Set image vertical size**</i>	X=Channel 1~4 Y= 0~1080
RVSIZE 1~4	<i>Show image vertical size current value**</i>	1~4=Channel 1~4
SHPOS X Y	<i>Set horizontal position of specified channel**</i>	X=Channel 1~4 Y= 0~1920
RHPOS 1~4	<i>Show image horizontal position current value**</i>	1~4=Channel 1~4
SVPOS X Y	<i>Set vertical position of specified channel**</i>	X=Channel 1~4 Y= 0~1080
RVPOS 1~4	<i>Show image vertical position current value**</i>	1~4=Channel 1~4
SIMAGE X Y	<i>Set output channel image on/off**</i>	X=Channel 1~4 Y= 0/1, 0=Off, 1=On
RIMAGE 0~4	<i>Show output channel image current**</i>	0=All channels, 1~4=Channel 1~4
SPRI X Y	<i>Set windows priority**</i>	X=Channel 1~4 Y=Priority 1~4
RPRI 0~4	<i>Show windows priority**</i>	0=All channels, 1~4=Channel 1~4
SLABEL X Y	<i>Assign a preset name**</i>	X=Channel 1~4 Y=A~Z and/or 0~9 (up to 9 characters)
RLABEL 0~4	<i>Show preset name to screen**</i>	0=All channels, 1~4=Channel 1~4
SSTORE 1~4	<i>Save the current window to FAV1~FAV4**</i>	1~4=FAV 1~4

COMMAND	DESCRIPTION	PARAMETER
SRECALL1~12	<i>Set a output windows to Windows A~Windows FAV4</i>	1=Window A, 2=Window B, 3=Window C, 4=Window D, 5=Window E, 6=Window F, 7=Window G, 8=Window H, 9=FAV 1, 10=FAV 2, 11=FAV 3, 12=FAV 4
SMIRROR 0/1	<i>Set enable/disable mirror effect *</i>	0=Off 1=On
RMIRROR	<i>Show mirror current to screen*</i>	
SFADE 0~21	<i>Set fade in-out time*</i>	0=Off, 1=1.0s, 2=1.1s, 3=1.2s, 4=1.3s, 5=1.4s, 6=1.5s, 7=1.6s, 8=1.7s, 9=1.8s, 10=1.9s, 11=2.0s, 12=2.1s, 13=2.2s, 14=2.3s, 15=2.4s, 16=2.5s, 17=2.6s, 18=2.7s, 19=2.8s, 20=2.9s, 21=3.0s (s=second)
RFADE	<i>Show fade in-out current to screen*</i>	
SROTATE 0~3	<i>Set video rotation video to preset positions *</i>	0=Off 1=R90 2=180 3=L90
RROTATE	<i>Show video rotation current to screen*</i>	

COMMAND	DESCRIPTION	PARAMETER
SCHRKS 0~9	<i>Set chromakey color for chroma key*</i>	0=User 1 1=User 2 2=White 3=Yellow 4=Cyan 5=Green 6=Magenta 7=Red 8=Blue 9=Black
RCHRKS	<i>Show chromakey color current to screen*</i>	
SCHRC X Y	<i>Set the YCbCr color range for the chromakey*</i>	X=0~11 0=User 1 Y Max 1=User 1 Y Min 2=User 1 Cb Max 3=User 1 Cb Min 4=User 1 Cr Max 5=User 2 Cr Min 6=User 2 Y Max 7=User 2 Y Min 8=User 2 Cb Max 9=User 2 Cb Min 10=User 2 Cr Max 11=User 2 Cr Min Y=16~240 (Value)
RCHRC 0~9	<i>Show chromakey current to screen*</i>	0=User 1 1=User 2 2=White 3=Yellow 4=Cyan 5=Green 6=Magenta 7=Red 8=Blue 9=Black

COMMAND	DESCRIPTION	PARAMETER
SCHRSW 0/1	Set enable/disable chromakey effect*	0=Off 1=On
RCHRSW	Show chromakey effect current to screen*	
SIPM 0/1	Set IP mode to DHCP or Static	0=DHCP 1=Static
RIPM	Show current IP mode to screen	
SIPADD XXX	Set static IP address	xxx.xxx.xxx.xxx (xxx=0~255)
RIPADD	Show static current IP address to screen	
SMAADD XXX	Set static subnet address	xxx.xxx.xxx.xxx (xxx=0~255)
RMAADD	Show static current subnet address to screen	
SGAADD XXX	Set static gateway address	xxx.xxx.xxx.xxx (xxx=0~255)
RGAADD	Show static current gateway address to screen	
SETHT 0~6	Set Ethernet timeout	0=Off, 1=10m, 2=20m, 3=30m, 4=40m, 5=50m, 6=60m (m=minute)
RETHT	Show Ethernet timeout current to screen	
RELINK	Relink the unit in 2 seconds	
SMAC X	Set MAC address	x=0~9 and/or A~F
RMAC	Show current MAC address to screen	
IPCONFIG	Show Ethernet address to screen	
DEFAULT	Reset the unit to factory defaults	
SVICH X Y	Set output video channel to specified source	X=Input 1~4 Y=0~4, 0=All channels, 1~4=Channel 1~4



COMMAND	DESCRIPTION	PARAMETER
RVICH	Show output channel the video source	
SMUTE 0/1	Set mute audio	0=Unmuted 1=Mute
RMUTE	Show current mute to screen	
SAUDIO 1~4	Set output audio to specified source	1~4=Input 1~4
RAUDIO	Show output audio source to screen	
SCHRE 0~4	Reset the Windows E~Windows FAV4 CH1~CH4 settings to factory defaults	0=All channels, 1~4=Channel 1~4
SWICORE	Reset the Windows A~Windows D settings to factory defaults	
RBIOS	Show bios version to screen	

Note:

1. Any commands will not be executed unless followed by a carriage return. Commands are case sensitive.
2. *Commands are executable under Window A~D selection.
3. **Commands are executable under Window E~H & FAV1~4.

6.7 Software Application

Please download the software from www.cypress.com.tw with file name CDPS V2.000 and save it in a directory where you may use it later.

Connect the unit with PC/Laptop through the Ethernet port of an active network system and open the CDPS V2.000 application. Click on Find Devices on Network and a list of the devices connected to the system will show up.

Double click on the product name and an InfoFrom will appear to show the products' detail.

Find Devices on Network				
	Product Name	Description	IP Address	MAC Address
1	CDPS-4S2HSS	4 x 2 SDI to HDMI Seamless	192.168.1.50	F8:22:85:00:04:AA
2	CDPS-4KQ	4K2K TV Wall	192.168.5.145	F8:22:85:00:03:2A

Then user may use the IP Address to find the control device through Telnet or WebGUI or even RS-232/Hyper Terminal tools.

Product ID	0100
Product Name	CDPS-4S2HSS
MAC Address	F8:22:85:00:04:AA
IP Address	<input type="text" value="192.168.1.50"/>
Subnet Mask	<input type="text" value="255.255.255.0"/>
Gateway IP	<input type="text" value="192.168.5.254"/>
DNS	<input type="text" value="0.0.0.0"/>
IP Mode	<input type="text" value="Static"/>
Web GUI Port	<input type="text" value="80"/>
Telnet Port	<input type="text" value="23"/>
S / N	SN:123-456
Firmware Version	V0.09
Hardware Version	PCB-2108*B
Description	4 x 2 SDI to HDMI Seamless
Web GUI	Web GUI
<input type="button" value="Save"/> <input type="button" value="Reboot"/>	

Note: The default IP setting is 192.168.1.50.

6.8 Telnet Control

To access the telnet control under MS windows, click 'Start' menu and type "cmd" in the search field then press enter.

Under Mac OS X, go to Go→Application→Utilities→Terminal.

See below for reference.

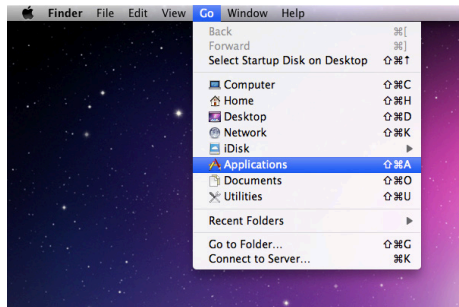
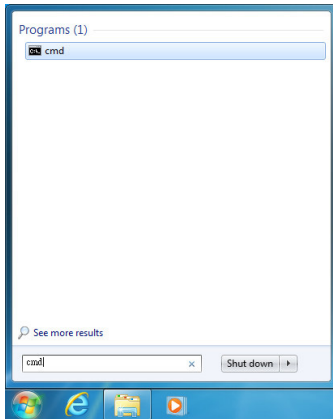

Once in the command line interface (CLI) type "telnet", then the IP address, and hit enter.

```
Microsoft Windows [Version 6.1.7601]
Copyright (c) 2009 Microsoft Corporation. All rights reserved.

C:\Users\Administrator>telnet 192.168.5.80 23
```

Press "Help" or "?" then hit enter to bring up all available commands.

```
Command List
HELP
SPOW
RPOW
SRES
RRES
SIO3DD
RIO3DD
SOSDH
ROS DH
SOSDU
ROSDU
SOSDT
ROSDT
SOSDG
ROSDG
SURI
RBRI
SCON
PCON
SSTAT
RSTAT
SPIRE
SIMRE
SUSIZE
RUSIZE
SUSIZE
RUSIZE
SIPOS
RIPOS
SUPOS
RUPOS
SIMAGE
RIMAGE
SPRI
RPRI
SLABEL
RLABEL
SSTORE
RSTORE
SREGALL
RREGALL
SRROR
RROR
SFADE
RFADE
SROTATE
RROTATE
SCHRNS
RCHRNS
SCHRC
RCHRC
SCHRSU
RCHRSU
SIPM
RIPM
SIPADD
RI PADD
SMPADD
RMPADD
SGADD
RSGADD
SETHI
RETHI
RELINX
SMAC
MPAC
IFORMFIG
DEFAULI
SUICH
RUICH
SMUTE
RMUTE
SAUDIO
RAUDIO
SCHRE
RCHRE
SUICOBE
RBIOS
```

Note: Any commands will not be executed unless followed by a carriage return. Commands are case-insensitive. If the IP is changed then the IP Address required for Telnet access will also change accordingly.

6.9 WebGUI Control

On a PC/Laptop that is connected to an active network system, open a web browser and type device's IP address (default setting IP:192.168.1.50) on the web address entry bar. The browser will display device's Image Adjust, Output Resolution, Window Setup, OSD Settings, Window Convert, Chromakey Setup & Ethernet pages for users to control.

6.9.1 Image Adjust

Click on 'Image Adjust' to show current I/O information and Channel input status. Set power status, select source settings and adjust each channel's contrast, brightness and saturation, or to set the setting back to default.

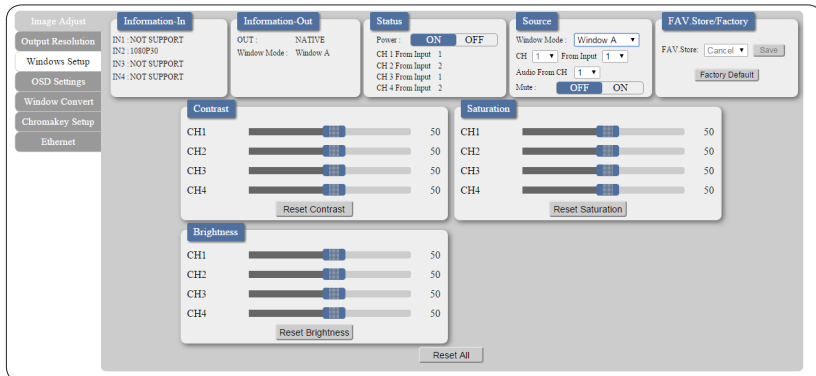

6.9.2 Output Resolution

Click on 'Output Resolution' to select both output ports' resolution, default setting is on Native and the device will reference output A's EDID.

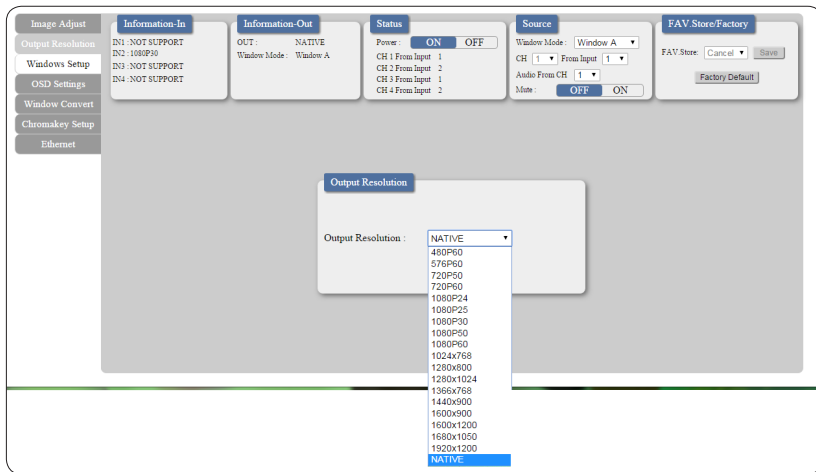

6.9.3 Window Setup

Click on 'Windows Setup' to select the window display format from E~H with its size and position, simply drag and pull each channel to the desired position. Once the setting is done it can be labeled and saved.

Note: This page is only selectable under Window mode E~H and under these modes Window Convert and Chromakey Setup will not be selectable.

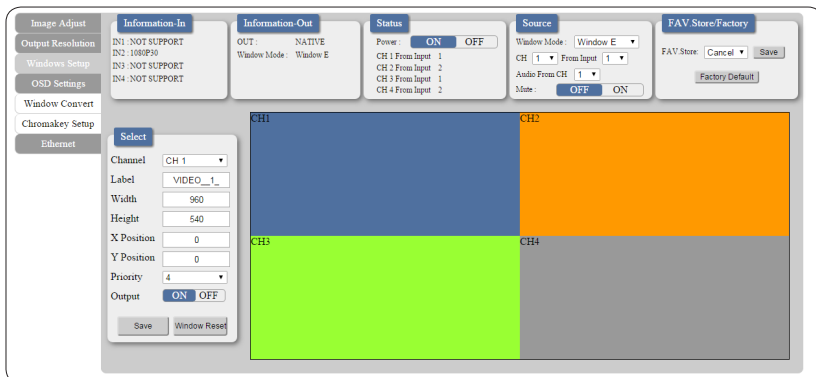

6.9.4 OSD Settings

Click on 'OSD Settings' to set OSD size, timeout and transparent settings and allow info display On or Off.

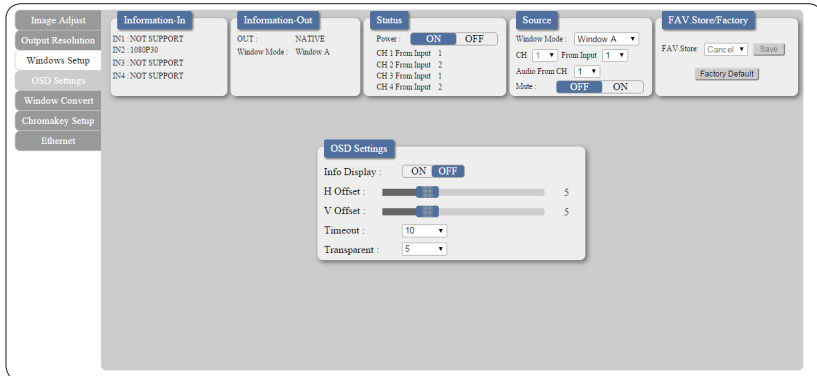

6.9.5 Window Convert

Click on 'Window Convert' to set each window's appearance by mirror, fade-in-out or rotation.

Note: This page is only selectable under Window mode A~D.



6.9.6 Chromakey Setup

Click on 'Chromakey Setup' to set each window's chromakey.

Note: This page is only selectable under Window mode A~D.

The screenshot shows the OSD menu with 'Chromakey Setup' selected. The main menu items are: Image Adjust, Information-In, Information-Out, Status, Source, and FAV Store/Factory. The 'Chromakey Setup' sub-menu is open, displaying the following settings:

- Color Sel : User1 [Save to User]
- Y Maximum : 240
- Y Minimum : 16
- Cb Maximum : 240
- Cb Minimum : 16
- Cr Maximum : 240
- Cr Minimum : 16
- Chromakey : ON OFF

6.9.7 Ethernet

Click on 'Ethernet' to set IP status, IP address and other IP related setting.

The screenshot shows the OSD menu with 'Ethernet' selected. The main menu items are: Image Adjust, Information-In, Information-Out, Status, Source, and FAV Store/Factory. The 'Ethernet' sub-menu is open, displaying the following settings:

- DHCP
- MAC : F8-22-85-00-04-AA
- IP Address : 192.168.1.50 [Save Changes]
- Netmask : 225.225.225.0 [Re-Link]
- Gateway : 192.168.5.254
- Telnet Timeout : OFF
- On
- 10 min
- 20 min
- 30 min
- 40 min
- 50 min
- 60 min

7. CONNECTION DIAGRAM

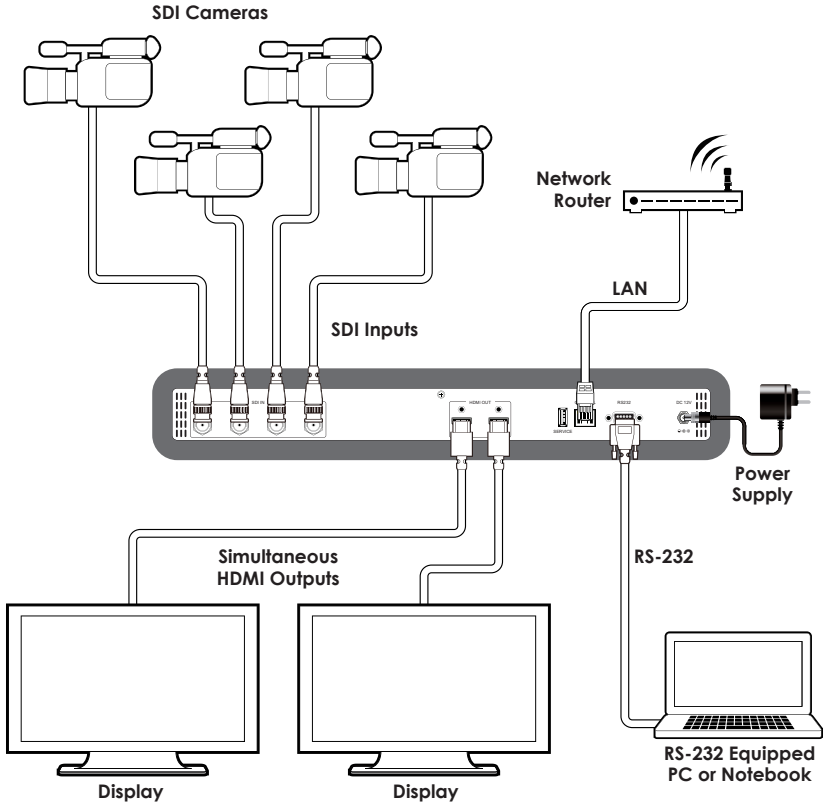

Screen Configurations

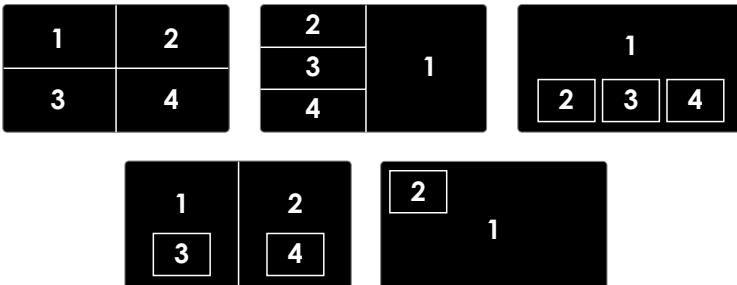

8. SPECIFICATIONS

SMPTE Standards	259M-C, 292M, 424M/425M-AB
SDI Transmission Rates	270Mbps, 1.485Gbps & 1.485/1.001 Gpbs, 2.970Gbps & 2.970/1.001 Gpbs
Video Bandwidth	225MHz/6.75Gbps
Input Ports	4×SDI
Output Ports	2×HDMI
SDI Timings Support	SD-SDI: SMPTE 259M-C@270Mbps HD-SDI: SMPTE292M@1.485 & 1.485/1.001 Gpbs 3G-SDI: SMPTE 424M/425M-AB@2.970 & 2.971/1.001 Gpbs
HDMI Timings Support	480i, 576i, 720p@50/59.94/60, 1080i@50/59.94/60, 1080p@23.98/24/25/29.97/30/50/59.94/60 & 1080PsF@23.98/24/25/29.97/30
SDI Cable Length	250m@SD-SDI, 200m@HD-SDI, 100m@3G-SDI (BELDEN 1694A cable)
HDMI Cable Length	5M/1080p@50/60
ESD Protection	Human Body Model: ±8kV (air-gap discharge) ±4kV (contact-gap discharge)
Power Supply	12V/3A DC (US/EU standards, CE/FCC/UL certified)
Dimensions	438 mm (W)×269 mm (D)×44 mm (H)/Jacks Excluded 482 mm (W)×274mm (D)×52 mm (H)/Jacks Included
Weight	2976g
Chassis Material	Metal
Silkscreen Color	Black
Operating Temperature	0°C~40°C / 32°F~104°F
Storage Temperature	20°C~60°C / -4°F~140°F
Relative Humidity	20~90% RH (non-condensing)
Power Consumption	20W



9. ACRONYMS

ACRONYM	COMPLETE TERM
CLI	Command Line Interface
DVI	Digital Visual Interface
GUI	Graphical User Interface
HDMI	High-Definition Multimedia Interface
IP	Internet Protocol
IR	Infrared
LAN	Local Area Network
OSD	On-Screen Display
LAN	Local Area Network
PIP	Picture-in-Picture
POP	Picture-out-of-Picture
SDI	Serial Digital Interface
SMPTE	Society of Motion Picture and Television Engineers
USB	Universal Serial Bus



CYPRESS TECHNOLOGY CO., LTD
Home page: <http://www.cypress.com.tw>

MPM-CDPS4S2HSS