



# CDPS-UH4H1HFS

4×1 HDMI 4K UHD Switcher  
with Control System Center



Operation Manual



## **DISCLAIMERS**

The information in this manual has been carefully checked and is believed to be accurate. Cypress Technology assumes no responsibility for any infringements of patents or other rights of third parties which may result from its use.

Cypress Technology assumes no responsibility for any inaccuracies that may be contained in this document. Cypress also makes no commitment to update or to keep current the information contained in this document.

Cypress Technology reserves the right to make improvements to this document and/or product at any time and without notice.

## **COPYRIGHT NOTICE**

No part of this document may be reproduced, transmitted, transcribed, stored in a retrieval system, or any of its part translated into any language or computer file, in any form or by any means—electronic, mechanical, magnetic, optical, chemical, manual, or otherwise—without express written permission and consent from Cypress Technology.

© Copyright 2017 by Cypress Technology.

All Rights Reserved.

## **TRADEMARK ACKNOWLEDGMENTS**

All products or service names mentioned in this document may be trademarks of the companies with which they are associated.





## SAFETY PRECAUTIONS

Please read all instructions before attempting to unpack, install or operate this equipment and before connecting the power supply.

Please keep the following in mind as you unpack and install this equipment:

- Always follow basic safety precautions to reduce the risk of fire, electrical shock and injury to persons.
- To prevent fire or shock hazard, do not expose the unit to rain, moisture or install this product near water.
- Never spill liquid of any kind on or into this product.
- Never push an object of any kind into this product through any openings or empty slots in the unit, as you may damage parts inside the unit.
- Do not attach the power supply cabling to building surfaces.
- Use only the supplied power supply unit (PSU). Do not use the PSU if it is damaged.
- Do not allow anything to rest on the power cabling or allow any weight to be placed upon it or any person walk on it.
- To protect the unit from overheating, do not block any vents or openings in the unit housing that provide ventilation and allow for sufficient space for air to circulate around the unit.

## REVISION HISTORY

VERSION NO.	DATE (DD/MM/YY)	SUMMARY OF CHANGE
VR0	10/11/15	Preliminary release
VS1	07/03/17	Updated text/diagrams



# CONTENTS

<b>1. Introduction</b> .....	<b>1</b>
<b>2. Applications</b> .....	<b>1</b>
<b>3. Package Contents</b> .....	<b>1</b>
<b>4. System Requirements</b> .....	<b>2</b>
<b>5. Features</b> .....	<b>2</b>
<b>6. Operation Controls and Functions</b> .....	<b>3</b>
6.1 Front Panel .....	3
6.2 Rear Panel.....	4
6.3 Remote Control.....	6
6.4 IR Cable Pin Assignment.....	6
6.5 RS-232 Protocol.....	7
6.6 RS-232 and Telnet Commands .....	7
6.7 Telnet Control .....	13
6.8 WebGUI Control .....	15
6.8.1 Routing Settings.....	16
6.8.2 Audio Settings.....	17
6.8.3 EDID Settings.....	17
6.8.4 Macro Settings .....	18
6.8.5 Command Settings.....	19
6.8.6 Network Settings .....	20
6.8.7 System Settings.....	21
<b>7. Connection Diagram</b> .....	<b>22</b>
<b>8. Specifications</b> .....	<b>23</b>
8.1 Technical Specifications .....	23
8.2 Video Specifications .....	24
8.3 Audio Specifications .....	25
<b>9. Acronyms</b> .....	<b>26</b>





## 1. INTRODUCTION

This 4×1 HDMI 4K UHD Switcher allows you to select between four HDMI sources and route your selection to a single HDMI display. Additionally, stereo audio is extracted, output, and amplified, without the need for a dedicated amp, via speaker connections on the back of the unit making it ideal for small events or classrooms. The included control system functionality provides access not only to direct but also indirect control interfaces for all of your devices. Direct control methods such as IR, RS-232, relay and DC triggers allow users to maintain traditional styles of control over devices while indirect device control is possible using Telnet, allowing users to control newer, more complicated, devices. The operation of the system can be easily managed through the included WebGUI by connecting with your PC, laptop or even a mobile device such as a tablet.

## 2. APPLICATIONS

- Home Theater with Smart Home Control
- Showroom Display with Kiosk Controls
- Security/Alarm Monitoring and Control
- Classrooms

## 3. PACKAGE CONTENTS

- 1×4 by 1 HDMI 4K UHD Switcher
- 1×Remote Control (CR-153)
- 1×IR Blaster Cable
- 1×3.5mm to 9-pin D-sub Female Connector
- 2×3-pin Terminal Blocks
- 1×5-pin Terminal Block
- 1×8-pin Terminal Block
- 1×24V/3.75A Power Adaptor
- 1×Power Cord
- 1×Operation Manual

## 4. SYSTEM REQUIREMENTS

- HDMI input source equipment such as media players, video game consoles or set-top boxes.
- HDMI receiving equipment such as HDTVs, monitors or audio amplifiers.
- Trigger input source equipment such as motion detection cameras, TVs, power switches, etc.
- An active internet connection from a switch or router for control of Ethernet devices.
- The use of "Premium High Speed HDMI" cables is highly recommended.

## 5. FEATURES

- HDMI with 3D and 4K UHD support, DVI 1.0 compatible
- Supports HDCP 1.4 for all HDMI inputs and outputs
- Supports resolutions up to 4K UHD: 3840×2160@24/25/30Hz & 3840×2160@50/60Hz (YUV 4:2:0), 4096×2160@24/25/30Hz & 4096×2160@50/60Hz (YUV 4:2:0)
- Supports HDMI data rates from 300Mbps up to 3Gbps and "Deep Color" up to 1080p w/ 36-bit color
- Supports auto source detection and switching
- Amplified stereo speaker outputs support LPCM 2.0 sources from HDMI or optical
- Supports simultaneous audio output over HDMI and analog stereo
- Per-input HDCP support control
- Supports system control with 5 IR outputs, 4 Trigger inputs, 4 Relay outputs, 2 COM ports, and 1 Ethernet port
- Supports 4 trigger inputs with a voltage range of 0~3.3V
- Supports COM port baud rates from 4800~115200bps
- Supports RS-232, IR, Telnet, and WebGUI controls

## 6. OPERATION CONTROLS AND FUNCTIONS

### 6.1 Front Panel

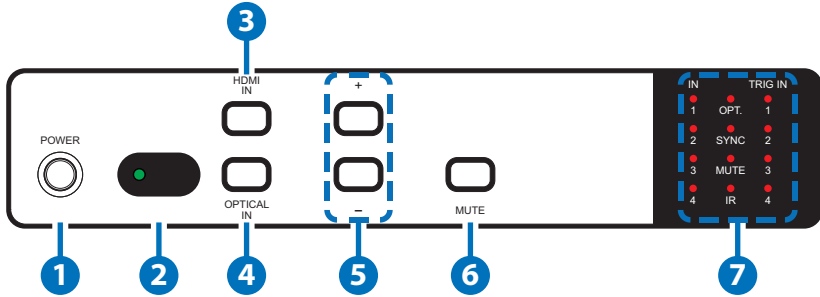

- 1 POWER & LED:** Press this button to power the unit on (green LED) or place it into stand-by mode (red LED).

*Note: To force the IP mode to switch from Static to DHCP press and hold the power button for 3 seconds while the unit is ON and the LED will blink once to indicate the change has occurred.*
- 2 IR Window & LED:** Accepts IR signals from the included IR remote for control of this unit only. The LED will blink when IR signals are received.
- 3 HDMI IN:** Press this button to sequentially switch through the 4 available HDMI inputs.
- 4 OPTICAL IN:** Press this button to select the optical input as the live audio for the analog stereo outputs. Press the “HDMI IN” button once to return to outputting the HDMI source’s audio.

*Note: The HDMI output will always follow the selected HDMI input’s audio. Only the analog speaker connections will output the audio from a selected optical source(LPCM 2.0 only).*
- 5 -/+ (MINUS/PLUS):** Press these buttons to adjust the audio volume up/down.
- 6 MUTE:** Press this button to mute the analog speaker output’s audio.

*Note: To return back to the unit’s factory defaults, press and hold this button while plugging the AC power into the unit.*
- 7 HDMI IN LED 1~4:** These LEDs will illuminate to indicate which source is currently selected.



**OPT IN LED:** This LED will illuminate when optical is selected as an audio source.

**SYNC LED:** This LED will illuminate when a valid HDMI source is detected from the currently selected input.

**MUTE LED:** This LED will illuminate when audio is muted. When the currently selected audio input is in an unsupported format, or absent, this LED will blink and analog output will be automatically muted.

**TRIGGER IN LEDs 1~4:** These LEDs will illuminate when their associated trigger input has been activated. The legal voltage threshold is from 0V to 3.3V and activation is determined by the system settings (rising, falling, or change).

## 6.2 Rear Panel

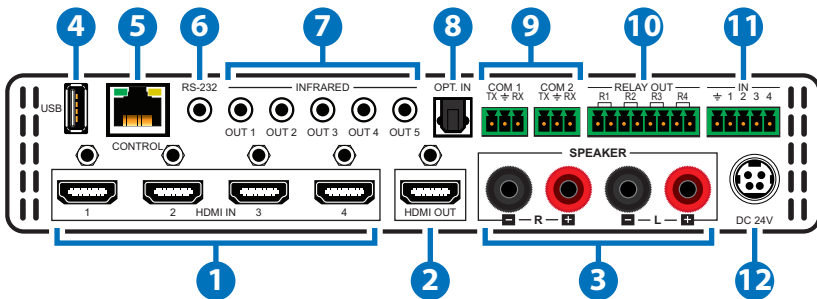

- HDMI IN:** Connect to HDMI source equipment such as media players, game consoles or set-top boxes.

*Note: This unit has an automatic source detection function and will automatically switch to the most recently connected/activated HDMI input. If the currently selected input is disconnected, or turns off, the unit will automatically switch to the next available live input.*

- HDMI OUT:** Connect to an HDMI TV, monitor or amplifier for digital video and audio output.

- SPEAKER OUT:** Connect to unpowered analog speakers using banana plug or bare-tipped speaker wire.

*Note: These terminals only support LPCM 2.0 audio sources, other formats will be automatically muted.*



- 4 **USB:** This slot is reserved for firmware update use only.
- 5 **CONTROL:** Connect to an active Ethernet network with an RJ-45 terminated cable to allow control of the unit via WebGUI and Telnet or to allow the unit to control other devices on the network.
- 6 **RS-232:** Connect directly to your PC/laptop using the provided cable to send RS-232 commands to control the unit.
- 7 **IR OUT 1~5:** Connect to the provided IR Blasters to transmit IR signals to devices within direct line-of-sight of the IR Blaster.
- 8 **OPT. IN:** Connect any LPCM 2.0 optical audio source to this port for output over the analog stereo output.
- 9 **COM 1~2:** Connect to RS-232 controllable devices to send commands to those devices via macros. Please use terminal block to DB-9 adapter cables.
- 10 **RELAY OUT 1~4:** Connect to devices that support DC relay trigger functionality to power or activate them via macro commands.
- 11 **TRIGGER IN 1~4:** Connect to any device with trigger or switch functionality such as window security alarms, motion detectors, door switches, etc. Each of the 4 trigger inputs will activate the associated macro when triggered.
- 12 **DC 24V:** Plug the 24V DC power adapter into the unit and connect it to an AC wall outlet for power.

### 6.3 Remote Control

- 1 **POWER:** Press this button to power the unit on or place it into stand-by mode.
- 2 **INPUT 1~4:** Press the button corresponding to the input you wish to display.
- 3 **OPTICAL:** Press this button to select the optical input as the live audio for the analog stereo outputs.
- 4 **MUTE:** Press this button to mute the analog speaker output audio. Press it again to unmute the audio.
- 5 **VOL +/-:** Press these buttons to adjust the audio volume up/down.

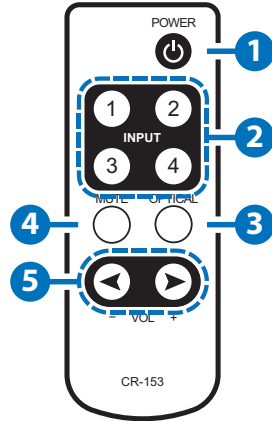

### 6.4 IR Cable Pin Assignment

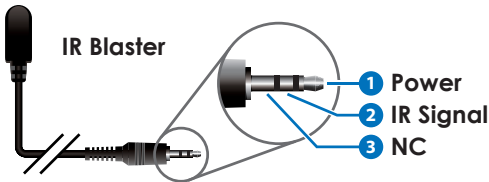

## 6.5 RS-232 Protocol

SWITCHER		REMOTE CONTROLLER	
Pin	Assignment	Pin	Assignment
1	NC	1	NC
2	TxD	2	RxD
3	RxD	3	TxD
4	NC	4	NC
5	GND	5	GND
6	NC	6	NC
7	NC	7	NC
8	NC	8	NC
9	NC	9	NC

Baud Rate: 115200bps

Data Bits: 8

Parity: None

Flow Control: None

Stop Bits: 1

## 6.6 RS-232 and Telnet Commands

COMMAND	DESCRIPTION
<b>HELP</b>	Show command list.
<b>?</b>	Show command list.
<b>HELP N</b>	Show command descriptions. N={Command Name}
<b>P0</b>	Power off (Stand-by).
<b>P1</b>	Power on.
<b>MUTE</b>	Show speaker mute status.

COMMAND	DESCRIPTION
<b>MUTE N</b>	Set speaker mute status. N=0~1 0=Unmuted 1=Muted
<b>SPEAKER</b>	Show speaker input source.
<b>SPEAKER N</b>	Set speaker input source. N=0~1 0=HDMI 1=Optical
<b>AUDIOFMT</b>	Show HDMI audio EDID behavior.
<b>AUDIOFMT N</b>	Set HDMI audio EDID behavior. N=0~1 0=PCM 1=Bypass
<b>SOUNDSYS</b>	Show speaker audio format.
<b>SOUNDSYS N</b>	Set speaker audio format. N=0~1 0=Stereo 1=Mono
<b>VOL</b>	Show speaker volume.
<b>VOL N</b>	Set speaker volume percentage to N. N=0~100 (%)
<b>A N</b>	Select input N. N=1~4, R (R selects the next input)
<b>IPCONFIG</b>	Display the current IP configuration.
<b>SIPADDR X.X.X.X</b>	Set Ethernet IP address. X=0~255
<b>SNETMASK X.X.X.X</b>	Set Ethernet netmask. X=0~255

COMMAND	DESCRIPTION
<b>SGATEWAY X.X.X.X</b>	Set Ethernet gateway. X=0~255
<b>HTTPPORT N</b>	Set HTTP port. N=0~65535
<b>RSTIP</b>	Reset IP configuration to DHCP.
<b>EDIDMODE</b>	Show EDID mode.
<b>EDIDMODE N</b>	Set EDID mode. N=0~1 0=Appoint 1=All
<b>EDIDALL</b>	Show EDID source for "All" mode.
<b>EDIDALL N</b>	Set EDID source for "All" mode. N=1~9 1=HDMI Output Native 2=8/2D/PCM/720p 3=8/2D/PCM/AC3/720p 4=8/2D/PCM/1080p 5=8/2D/PCM/AC3/1080p 6=8/2D/PCM/4K2K 7=8/2D/PCM/AC3/4K2K 8=8/2D/PCM/Y420 9=8/2D/AC3/Y420
<b>EDIDIN</b>	Show all EDID selections for "Appoint" mode.
<b>EDIDIN N1</b>	Show input N1's EDID selection for "Appoint" mode. N1=1~4

COMMAND	DESCRIPTION
<b>EDIDIN N1 N2</b>	Set input N1's EDID selection for "Appoint" mode.  N1=1~4  N2=1~9  1=HDMI Output Native 2=8/2D/PCM/720p 3=8/2D/PCM/AC3/720p 4=8/2D/PCM/1080p 5=8/2D/PCM/AC3/1080p 6=8/2D/PCM/4K2K 7=8/2D/PCM/AC3/4K2K 8=8/2D/PCM/Y420 9=8/2D/AC3/Y420
<b>HDCPIN</b>	Show the HDCP status for all inputs.
<b>HDCPIN N1</b>	Show the HDCP status for input N1.  N1=1~4
<b>HDCPIN N1 N2</b>	Set the HDCP support for input N1.  N1=1~4  N2=0~1 0=Disable 1=Enable
<b>SOURCEDET</b>	Show detection status of all inputs.
<b>SOURCEDET N1</b>	Show detection status of input N1.  N1=1~4
<b>SINKINFO</b>	Show connected display information.
<b>INNAME</b>	Show all HDMI inputs' names.
<b>INNAME N1</b>	Show HDMI input N1's name.  N1=1~4

COMMAND	DESCRIPTION
<b>INNAME N1 N2</b>	Set HDMI input N1's name. N1=1~4 N2={Name} (8 characters max, no spaces)
<b>OUTNAME</b>	Show HDMI output's name.
<b>OUTNAME A N1</b>	Set HDMI output's name. N1={Name} (8 characters max, no spaces)
<b>RELAY N N1</b>	Set Relay N's state. N=1~4 (Relay Port) N1=OPEN, CLOSE, TOGGLE, STATUS
<b>IREMIT IR N1 N2 N3</b>	Send IR content. N1=1~8 (IR Port) N2=0 (Format) N3={IR Data String}
<b>TRIGGER STATUS</b>	Show current status of all Triggers.
<b>TRIGGER INFO</b>	Show settings for all Triggers.
<b>TRIGGER INFO N</b>	Show settings for specified Trigger. N=1~4 (Trigger Port)
<b>TRIGGER ACTIVE N N1</b>	Enable or disable Trigger N. N1=1~4 (Trigger Port) N2=ENABLE, DISABLE
<b>TRIGGER MODE N N1</b>	Set Trigger N's activation method. N1=1~4 (Trigger Port) N2=RAISING, FALLING, CHANGE
<b>COMSEND COM N1 N2</b>	Send a command over the designated COM port. N1=1~2 (COM Port) N2={Command Data}



COMMAND	DESCRIPTION
<b>COMCONF COM N1</b>	Show the current COM port configuration. N1=1~2 (COM Port)
<b>COMCONF COM N1 N2 N3 N4 N5</b>	Set the COM port configuration. N1=1~2 (COM Port) N2=4800, 9600, 19200, 38400, 57600, 115200 (Baud Rate) N3=5~8 (Data Bits) N4=0~2 (Parity) 0=None 1=Odd 2=Even N5=1~2 (Stop Bits)
<b>MACRO RUN N</b>	Run Macro N. N=1~8 (Macro Number)
<b>VER</b>	Show the unit's firmware version.
<b>REBOOT</b>	Reboot the unit.
<b>FADEFAULT</b>	Reset all configurations and settings to the factory defaults.

*Note:*

- *Commands will not be executed unless followed by a carriage return. Commands are not case-sensitive.*
- *Some COMSEND commands may require carriage returns within the sent Command Data to be accepted by the destination device. Use \r or \x0D to insert carriage returns into the command.*
- *If the unit is power cycled the EDID mode will return to Mode 1 (HDMI output native).*

## 6.7 Telnet Control

Before attempting to use telnet control, please ensure that both the unit and the PC/Laptop are connected to the same active networks.

To access Telnet in Windows 7, click on the “Start” menu and type “cmd” in the search field, then press “Enter”. Under Windows XP go to the “Start” menu, click on “Run”, type “cmd” then press “Enter”. Under Mac OS X, go to “Go→Applications→Utilities→Terminal”. See below for reference.

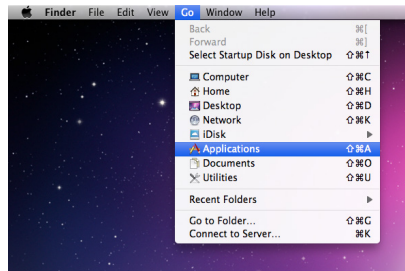
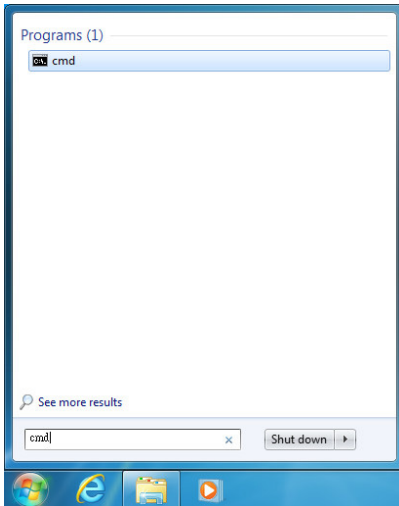

Once in the CLI (Command Line Interface) type “telnet” followed by the IP address of the unit and “23”, then hit “Enter”.

```
Microsoft Windows [Version 6.1.7601]
Copyright (c) 2009 Microsoft Corporation. All rights reserved.

C:\Users\Administrator>telnet 192.168.5.80 23
```

This will connect us to the unit we wish to control. Type “help” to list the available commands.

```

>?
?          : SHOW DESCRIPT OF COMMAND
           USE <? N, N=COMMAND NAME> TO SHOW DESCRIPT OF COMMAND
HELP      : SHOW DESCRIPT OF COMMAND
           USE <HELP N, N=COMMAND NAME> TO SHOW DESCRIPT OF COMMAND
P0        : POWER OFF
P1        : POWER ON
MUTE      : AMP MUTE MODE
AUDIOFMT  : EDID AUDIO FORMAT
SPEAKER   : SPEAKER MODE
SOUNDSYS  : SOUND SYSTEM
VOL       : VOLUME
IPCONFIG  : DISPLAY THE CURRENT IPCONFIG
SIPADDR   : SET ETHERNET IP ADDRESS
SNETMASK  : SET ETHERNET NETMASK
SGATEWAY  : SET ETHERNET GATEWAY
HTTTPORT  : SET HTTP PORT NUMBER
RSTIP     : IP MODE RESET TO DHCP
A         : SET HDMI OUTPUT SOURCE
EDIDMODE  : EDID MODE
EDIDALL   : EDID MODE SOURCE FOR ALL
EDIDIN    : INPUT EDID SOURCE
HDCPIN    : INPUT HDCP STATUS
SOURCEDET : SOURCE SIGNAL DETECT <ON/OFF>
SINKINFO  : SINK INFORMATION
INNAME    : INPUT NAME
OUTNAME   : OUTPUT NAME
RELAY     : RELAY CONTROL
TRIGGER   : TRIGGER STATUS&CONFIGURE
IREMIT    : SEND IR CONTENET
COMSEND   : SEND COMMAND TO COM PORT
COMCONF   : DRIVER RS232 CONFIG
MACRO     : MACRO CONTROL
VER       : SHOW UNIT FIRMWARE UERSION
REBOOT    : SYSTEM REBOOT
FAEFAULT  : ALL CONEFIGURE SET TO FACTORY DEFAULT
  
```

Note:

- *Commands will not be executed unless followed by a carriage return. Commands are not case-sensitive.*
- *If the IP address is changed then the IP address required for Telnet access will also change accordingly.*

## 6.8 WebGUI Control

- **Install the Device Discovery Tool**

Please obtain the Device Discovery software from your authorized dealer and save it in a directory where you can easily find it. Connect the unit and your PC/Laptop to the same active network and execute the Device Discovery software. Click on “Find Devices on Network” and a list of devices connected to the local network will show up indicating their current IP address.

*Note: The unit's default static IP address is 192.168.1.50*

Product Name	Description	IP Address	MAC Address

By clicking on one of the listed devices you will be presented with the network details of that particular device. If you choose, you can alter the static IP network settings for the device, or switch the unit into DHCP mode to automatically obtain proper network settings from a local DHCP server. To switch to DHCP mode, please select DHCP from the IP mode drop-down, then click “Save” followed by “Reboot”.

Product ID  
Product Name  
MAC Address 00:00:00:00:00:00  
IP Address  
Subnet Mask  
Gateway IP  
DNS  
IP Mode Static  
Web GUI Port 0  
Telnet Port 0  
S / N  
Firmware Version  
Hardware Version  
Description  
Web GUI [Web GUI](#)  
Save Reboot

Once you are satisfied with the network settings, you may use them to connect via Telnet or WebGUI. The network information window provides a convenient link to launch the WebGUI directly.

- **Login to the WebGUI**

Open a web browser on a PC/Laptop that is connected to an active network and type the device's IP address into the web address entry bar. The login screen will appear and ask for a Username and Password. The default username and password is "admin". Please enter the information and then click "Submit" to log in.

*Note: The default static IP address is 192.168.1.50*

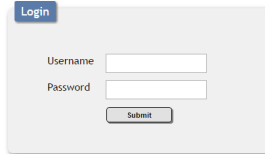



On the left side of the browser you will see the following menu tabs: Routing, Audio, EDID, Macro Settings, Command Settings, Network Settings, and System Settings to allow for user configuration of the unit.

### 6.8.1 Routing Settings

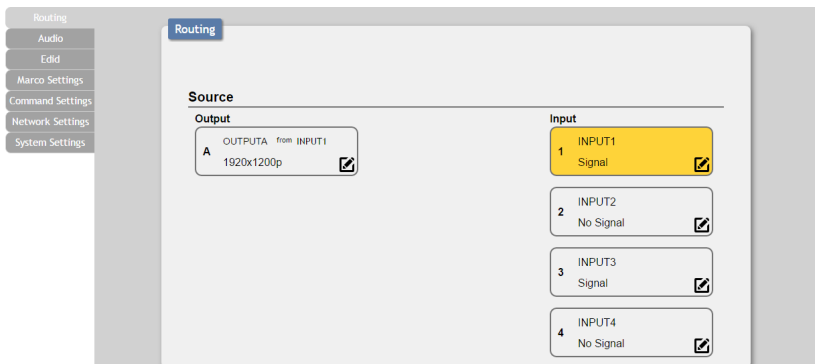
Click on the "Routing" tab to control the switching function of this unit. To begin assigning a new video route, please click the button of the input you wish to display (e.g. "INPUT1"). As you select an input the button's color will change to orange. The new source will become active immediately after selecting it.



**Renaming I/O:** All inputs and outputs can be renamed as required (up to 8 characters long with no spaces). Click on the  icon to change the input and output port names. Click on the  icon to confirm the changes.

## 6.8.2 Audio Settings

Click on the "Audio" tab to set the HDMI audio EDID format (Bypass or PCM) for the unit as well as the sound system format (mono or stereo), analog speaker source (optical or HDMI), volume level and mute setting for the connected analog speakers.

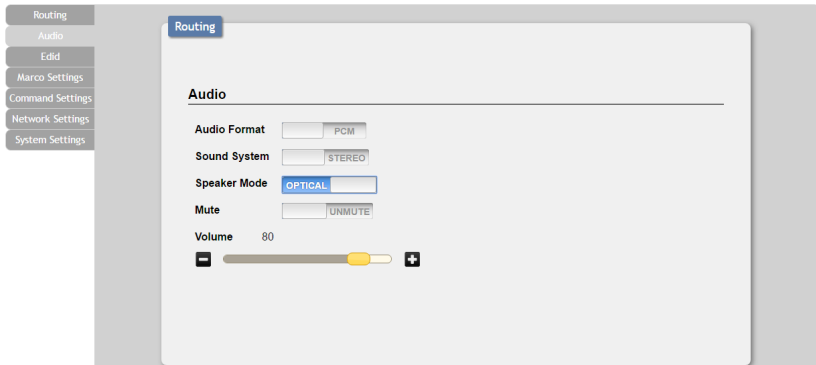

## 6.8.3 EDID Settings

Click on the "EDID" tab to select the EDID Mode and the EDID(s) to use. select "All" to pick a single EDID to be sent to all inputs. Select "Appoint" to pick individual EDIDs for each input. You can choose to use the EDID from your connected display device, or you may choose from one of the built in EDIDs.

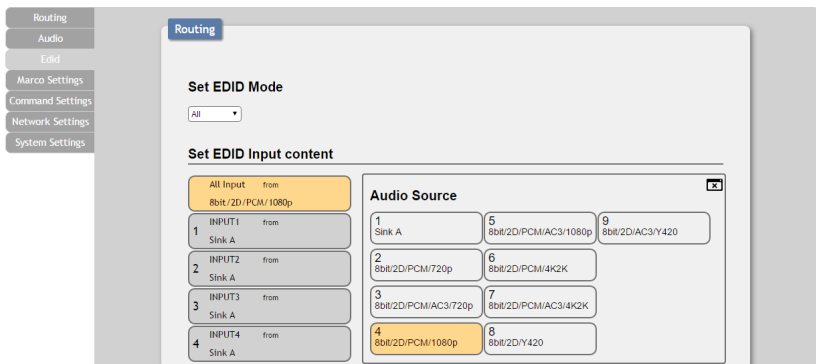

## 6.8.4 Macro Settings

Click on the "Macro Settings" tab to execute/edit the 8 available macros. These macros can be executed by activating the 4 input triggers on the back of the unit as well as via the WebGUI or Telnet. Each macro can contain up to 16 individual commands.

Macros 1~4 are assigned to Trigger In 1~4. When a trigger is activated the unit will execute the associated macro command.

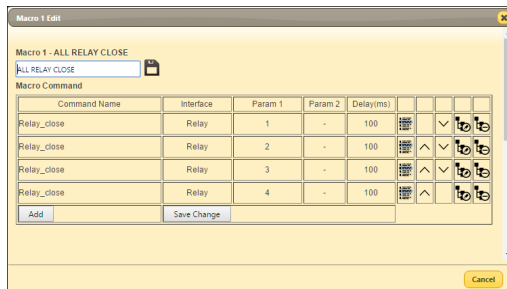
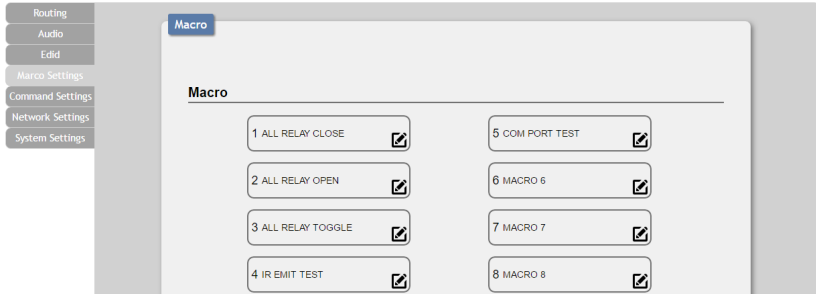

Click on the icon to edit each button's macro. At the top of the Macro edit window is a text field where you can edit the name of the macro. Type your new macro name into the box and then click the icon to save it.

Within the edit window the up/down arrows will change the command execution order. The icon allows you to edit the delay and interface for the command. The icon allows you to delete the command.

Click on the icon to insert a new command before the current one. Select one of the pre-defined commands from the list. (Details on how to create these pre-defined commands are later in this section.)

After selecting a command, you will need to choose the delay and interface for the command.

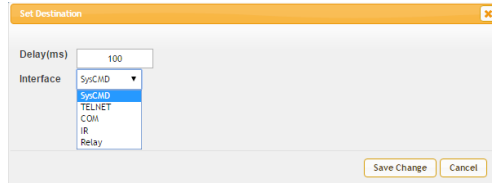

- (1) Delay(ms):** This setting is the length of time to wait before sending the next command and is set in milliseconds.
- (2) Interface:** The interface for sending commands can be set to the unit itself (SysCMD), to a specified IP address (TELNET), to a specified RS-232 port (COM), to a specified IR port (IR) or to trigger a relay port (Relay). Sending commands to devices on the local network, or across the internet requires the IP address and network port number of the destination device.

Once the destination information is complete please click on “Save Change”.

*Note: It is strongly suggested to not set a delay time less than 100ms for system, RS-232, IR, and relay commands or less than 500ms for Telnet commands to ensure that the command is properly received and executed before the next command is sent.*

When you have finished editing the macro click on “Save Change”.

### 6.8.5 Command Settings

Click on the “Command Settings” tab to create, edit or delete commands. The number of commands that can be stored in the unit is limited by memory. It is generally recommended that commands be under 128 characters long (including spaces). However, if longer commands are needed there is limited support for commands up to 512 characters long. In this case the number of (up to) 512 character commands is limited to 32 and the remaining 96 commands must be under 128 characters.



Command Name	Command	Edit	Delete
Relay_close	CLOSE	Edit	Remove
Relay_open	OPEN	Edit	Remove
Relay_toggle	TOGGLE	Edit	Remove
IR_Data	9333,1-156,A9,16,15,15,40,16,5E1,156,55,15,75C-011111112222222211221111222113-45-	Edit	Remove
COM_Data	Hello World!@#v0a	Edit	Remove
COMMAND 6		Edit	Remove
COMMAND 7		Edit	Remove
COMMAND 8		Edit	Remove
COMMAND 9		Edit	Remove
COMMAND 10		Edit	Remove
COMMAND 11		Edit	Remove
COMMAND 12		Edit	Remove
COMMAND 13		Edit	Remove
COMMAND 14		Edit	Remove
COMMAND 15		Edit	Remove
COMMAND 16		Edit	Remove

To create or edit a command, click on the "Edit" button next to the command you wish to change. Then, simply, enter the text command into the entry window that pops up. You may rename the command if you wish by changing the text in the "Command Label" field. Click on "Save Change" to save the command.

*Note: Some commands may require a carriage return (e.g. \r or \x0D) at the end to be accepted by the destination device.*

### 6.8.6 Network Settings

Click on the "Network Settings" tab to change the network settings for the unit. You can manually set the IP address, netmask and gateway address in "Static IP" mode, or you can obtain an IP address automatically by enabling DHCP. You may also change the default HTTP and Telnet ports used by the unit here. Click on "Save" to save your updated network settings.

Network
<p><b>Network Settings</b></p> <p>IP Mode: <input type="text" value="STATIC IP"/></p> <p>IP: <input type="text" value="192.168.1.50"/></p> <p>Netmask: <input type="text" value="255.255.255.0"/></p> <p>Gateway: <input type="text" value="192.168.1.254"/></p> <p>HTTP Port: <input type="text" value="80"/></p> <p>Telnet Port: <input type="text" value="23"/></p> <p><input type="button" value="Save"/> <input type="button" value="Network Reset"/></p>

Version.v2.20

## 6.8.7 System Settings

Click on the "System Settings" tab to make changes to various system settings. From this tab you can change the WebGUI login password and power the unit on/off (stand-by). You may also save the full system configuration, including all macros, to your connected PC/ Laptop or restore them from a previously saved configuration. Finally, this tab provides buttons to reset the unit to factory defaults and to reboot the unit.

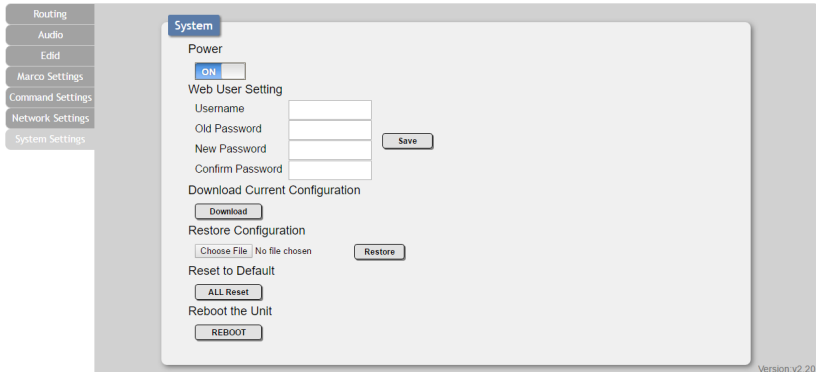

*Note: Please ensure that all commands and settings have been backed up before performing an "All Reset" as the procedure will return all settings back to the factory defaults.*

## 7. CONNECTION DIAGRAM

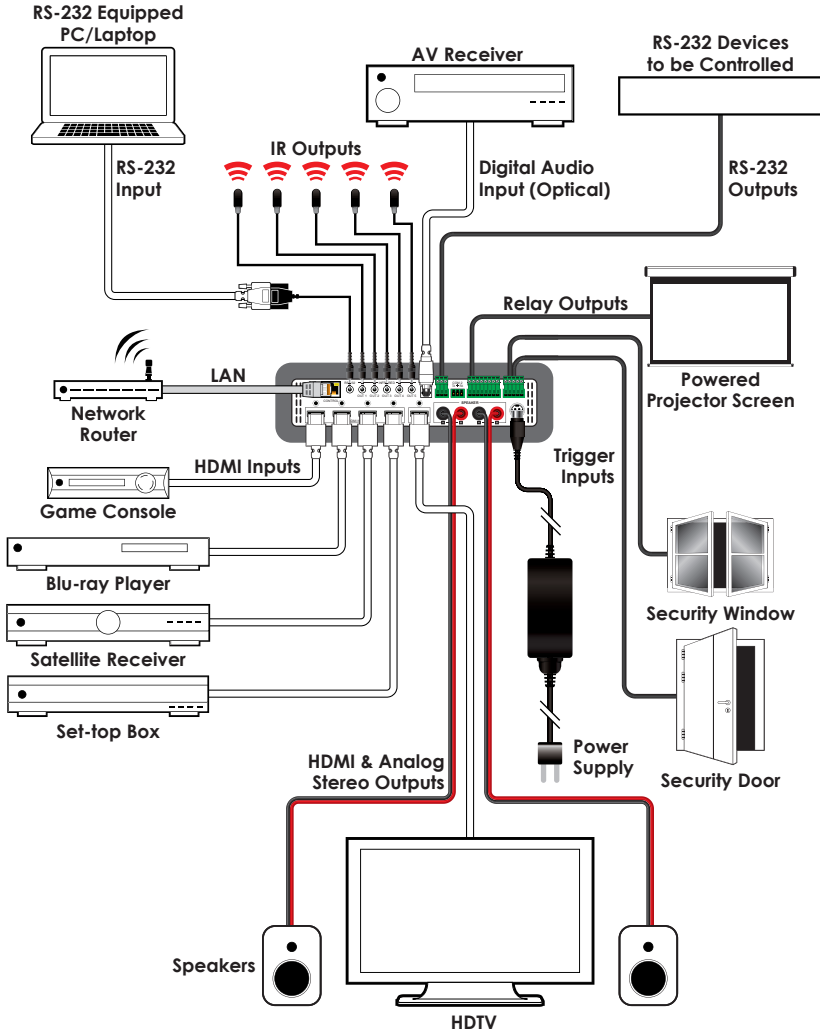



## 8. SPECIFICATIONS

### 8.1 Technical Specifications

<b>Video Bandwidth</b>	340MHz/10.2Gbps
<b>Input Ports</b>	4×HDMI, 1×Optical Audio, 4×Trigger (5-pin Terminal Block)
<b>Output Ports</b>	1×HDMI, 1×Stereo Speaker (Binding Post Pairs), 5×IR Blaster (3.5mm), 4×Relay (8-pin Terminal Block), 2×COM (3-pin Terminal Block)
<b>Control Interfaces</b>	1×IP Control (RJ-45), 1×RS-232 (3.5mm)
<b>Supported Resolutions</b>	480i@60Hz - 4K@60Hz (4:2:0, 8-bit) VGA@60Hz - WUXGA@60Hz (RB)
<b>Cable Length</b>	10m (1080p@60Hz, 12-bit) 5m (4K@60Hz, 4:2:0, 8-bit)
<b>IR Frequency</b>	30 - 50kHz (30 - 60kHz under ideal conditions)
<b>Baud Rate</b>	Up to 115200ps
<b>Power Supply</b>	24V/3.75A DC (US/EU standards, CE/FCC/UL certified)
<b>ESD Protection</b>	Human Body Model: ±12kV (Air Discharge) ±8kV (Contact Discharge)
<b>Dimensions</b>	219mm×43mm×156mm (W×H×D) [Case Only] 219mm×45mm×176.5mm (W×H×D) [All Inclusive]
<b>Weight</b>	1,272g
<b>Chassis Material</b>	Metal
<b>Silkscreen Color</b>	Black
<b>Operating Temperature</b>	0°C - 40°C/32°F - 104°F

<b>Storage Temperature</b>	-20°C - 60°C/-4°F - 140°F
<b>Relative Humidity</b>	20 - 90% RH (No-condensing)
<b>Power Consumption</b>	60W

## 8.2 Video Specifications

Supported Resolutions (Hz)	Input	Output
640×480@60/72/75	✓	✓
800×600@60/72/75	✓	✓
1024×768@60/70/75	✓	✓
1280×768@60	✓	✓
1280×800@60	✓	✓
1280×1024@60	✓	✓
1360×768@60	✓	✓
1600×1200@60	✓	✓
720×480p@60	✓	✓
720×576p@50	✓	✓
1280×720p@50/60	✓	✓
1920×1080i@50/60	✓	✓
1920×1080p@24/25/30/50/60	✓	✓
3840×2160p@24/25/30	✓	✓
3840×2160p@50/60 (YUV 4:2:0)	✓	✓
4096×2160p@24/25/30	✓	✓
4096×2160p@50/60 (YUV 4:2:0)	✓	✓



### 8.3 Audio Specifications

Supported Audio Format	Input		Output	
	HDMI	Optical	HDMI	Speakers
<b>LPCM 2.0</b>	✓	✓	✓	✓
<b>LPCM 5.1</b>	✓		✓	
<b>LPCM 7.1</b>	✓		✓	
<b>Bitstream</b>	✓		✓	
<b>HD Bitstream</b>	✓		✓	

2×45W@4Ω<0.5%THD+N

2×12W@8Ω<0.5%THD+N

Frequency Response <+/-1dB

SNR>70dB@20Hz~20kHz A-weighted

THD+N@1W<0.05%@1kHz

THD+N@1W<0.1%@20Hz~20kHz

## 9. ACRONYMS

ACRONYM	COMPLETE TERM
<b>CLI</b>	Command Line Interface
<b>DVI</b>	Digital Visual Interface
<b>EDID</b>	Extended Display Identification Data
<b>GUI</b>	Graphical User Interface
<b>HD</b>	High-Definition
<b>HDCP</b>	High-bandwidth Digital Content Protection
<b>HDMI</b>	High-Definition Multimedia Interface
<b>HDTV</b>	High-Definition Television
<b>HTTP</b>	HyperText Transfer Protocol
<b>IR</b>	Infrared
<b>LAN</b>	Local Area Network
<b>LPCM</b>	Linear Pulse-Code Modulation
<b>OLED</b>	Organic Light-Emitting Diode
<b>PC</b>	Personal Computer
<b>PCM</b>	Pulse-Code Modulation
<b>UHD</b>	Ultra-High-Definition
<b>USB</b>	Universal Serial Bus
<b>VGA</b>	Video Graphics Array (640×480@60Hz)
<b>WUXGA</b>	Wide Ultra Extended Graphics Array (1920×1200@60Hz)



**CYPRESS TECHNOLOGY CO., LTD.**

[www.cypress.com.tw](http://www.cypress.com.tw)