



# CDPS-U10H2HFS

10 By 2 HDMI Matrix Fast Switch



Operation Manual





## **DISCLAIMERS**

The information in this manual has been carefully checked and is believed to be accurate. Cypress Technology assumes no responsibility for any infringements of patents or other rights of third parties which may result from its use.

Cypress Technology assumes no responsibility for any inaccuracies that may be contained in this document. Cypress also makes no commitment to update or to keep current the information contained in this document.

Cypress Technology reserves the right to make improvements to this document and/or product at any time and without notice.

## **COPYRIGHT NOTICE**

No part of this document may be reproduced, transmitted, transcribed, stored in a retrieval system, or any of its part translated into any language or computer file, in any form or by any means - electronic, mechanical, magnetic, optical, chemical, manual, or otherwise - without express written permission and consent from Cypress Technology.

© Copyright 2014 by Cypress Technology.

All Rights Reserved.

Version 1.0 November 2014

## **TRADEMARK ACKNOWLEDGMENTS**

All products or service names mentioned in this document may be trademarks of the companies with which they are associated.



## SAFETY PRECAUTIONS

Please read all instructions before attempting to unpack or install or operate this equipment, and before connecting the power supply.

Please keep the following in mind as you unpack and install this equipment:

- Always follow basic safety precautions to reduce the risk of fire, electrical shock and injury to persons.
- To prevent fire or shock hazard, do not expose the unit to rain, moisture or install this product near water.
- Never spill liquid of any kind on or into this product.
- Never push an object of any kind into this product through module openings or empty slots, as you may damage parts.
- Do not attach the power supply cabling to building surfaces.
- Do not allow anything to rest on the power cabling or allow it to be abused by persons walking on it.
- To protect the equipment from overheating, do not block the slots and openings in the module housing that provide ventilation.

## REVISION HISTORY

VERSION NO.	DATE DD/MM/YY	SUMMARY OF CHANGE
VR0	22/06/15	Preliminary Release

## CONTENTS

<b>1. Introduction</b> .....	<b>1</b>
<b>2. Applications</b> .....	<b>1</b>
<b>3. Package Contents</b> .....	<b>1</b>
<b>4. System Requirements</b> .....	<b>1</b>
<b>5. Features</b> .....	<b>2</b>
<b>6. Operation Controls and Functions</b> .....	<b>3</b>
6.1 Front Panel .....	3
6.2 Rear Panel.....	5
6.3 Remote Control.....	6
6.4 OSD Menu .....	8
6.5 RS-232 Protocols .....	14
6.6 IR Pin Definitions.....	14
6.7 IP Searching Software Application and Installation .....	15
6.8 Telnet & RS-232 Commands.....	16
6.9 Telnet Control .....	18
6.10 WebGUI Control .....	20
<b>8. Specifications</b> .....	<b>24</b>



## 1. INTRODUCTION

This 10 by 2 HDMI UHD Matrix is an advanced solution for switching up to 10 HDMI inputs to two HDMI outputs. It provides high performance pass-through of video/audio and is capable of receiving and transmitting 300MHz/9Gbps bandwidth rate with no data loss. It's Fast Switching technology can greatly reduce the time required to swap between inputs. Supporting the latest features you can be assured of reliable and high quality HDMI distribution.

## 2. APPLICATIONS

- Showroom display & control
- Educational demo
- Installation usage
- Advertising display

## 3. PACKAGE CONTENTS

- 10 By 2 HDMI Matrix Fast Switch
- 1 x IR Extender
- 1 x Remote Control with Battery
- 1 x 5V/2.6A Power Adaptor
- 1 x Left & Right Ear Racks
- Operational Manual

## 4. SYSTEM REQUIREMENTS

Input source equipment such as DVD/Blu-ray player and output HD display/Monitor with HDMI cables.

## 5. FEATURES

- Supports UHD resolutions up to 4K2K@24/25/30Hz & 4K2K YUV420@60Hz
- Supports HDTV resolutions up to 1080@60Hz, 'Deep Color' 36/30/24-bit and PC resolutions up to WUXGA@60Hz(RB)
- Supports 3D
- Supports pass-through of audio formats: LPCM 2/5.1/7.1CH, Dolby Digital 2~5.1CH, DTS 2~5.1CH, Dolby Digital Plus, Dolby TrueHD, Dolby Atmos and DTS-HD Master Audio
- Supports EDID selection function
- Supports control via IR, RS-232, Telnet and WebGUI controls
- Input port HDCP support Standard and Apple mode. The Apple mode selection to guarantees the use of Apple devices.
- Compliant with DVI source

**Note:** Supporting HDMI to DVI conversion when HDMI sources is non-deep color and color space RGB.



## 6. OPERATION CONTROLS AND FUNCTIONS

### 6.1 Front Panel

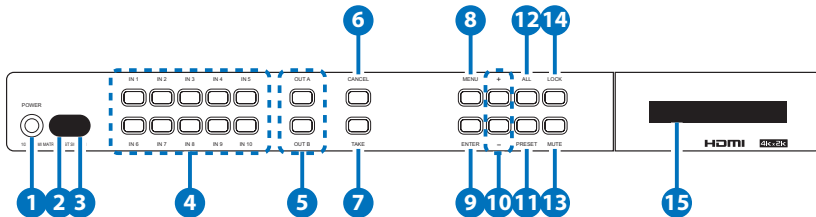

#### 1 POWER Button

Press this button to switch On or set the device to standby mode.

#### 2 POWER LED

This LED will illuminate in green when the device is power On and if it is switched to standby mode the LED will turn red.

#### 3 IR Window

This IR Receiver receives the remote control signal from the package included remote control only.

#### 4 IN 1~10

Press these IN buttons to select an input from the 10 input sources.

#### 5 OUT A/B

Press these buttons once a time along with an IN buttons to select an input source for an output display. i.e. OUTA → IN1 → TAKE or OUTB → IN10 → TAKE.

#### 6 CANCEL

Press this button to cancel the IN/OUT selection and during any selection under MENU.

#### 7 TAKE

Press this button to confirm the selection of an IN and an OUT button. If this button is not pressed the IN & OUT selection will not be executed.

#### 8 MENU

Press to enter into the menu selection.



**9 ENTER**

Press to confirm the selection.

**10 +/-**

Press these buttons to move up/down under menu selection.

**11 PRESET**

Press this button to recall the preset setting from 1~10. Press and select from IN1~10 then press TAKE to confirm the recall selection or press CANCEL to exit the selection. To reset the Preset setting, enter into menu and select Preset setting from IN1~10 then press OUTA and select an input from IN1~10 then press OUTB and select an input from IN1~10 again and press ENTER to confirm the selection. eg. To preset 2's figure, MENU → ENTER → Matrix Preset → Enter → Preset2 → IN2 → OUTA → IN8 → OUTB → IN7 → ENTER

**12 ALL**

Press this button to select all outputs to display with an input source. e.g. To select all output with input source 3. ALL → IN3

**13 MUTE**

Press this button to mute video and audio on OUT A or B or on all output. e.g. To mute output A OUTA → MUTE

**14 LOCK**

Press this button to lock all button functions on the panel to unlock, press the button and hold for 3 seconds.

**15 LCM**

Displaying Input and Outputs selection and menu selection.



## 6.2 Rear Panel

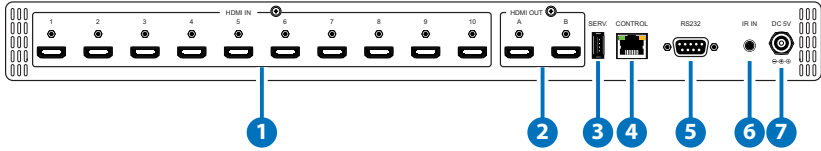

### 1 HDMI IN

Connect from source equipment such as Blu-ray/DVD/PS3 players, Set-Top-Box or any HDMI equipped source device for input signal sending.

### 2 HDMI OUT

Connect to HDMI TV/display or HD Amplifier for output image and or audio display.

### 3 SERV.

This slot is reserved for firmware update use only.

### 4 CONTROL

Connect from PC/Laptop with active internet service for Telnet or WebGUI control with RJ-45 terminated cable.

### 5 RS-232

Connect from PC/Laptop for RS-232 command sending to control the device.

### 6 IR IN

Connect the IR Receiver included in the package for IR signal receive from the included remote control.

### 7 DC 5V

Connect the adaptor included in the package and connect to AC wall outlet for power supply.

## 6.3 Remote Control

### 1 POWER

Press this button to switch On or set the device to standby mode.

### 2 MUTE

Press this button to mute video and audio on OUT A or B or on all output. e.g. To mute output A OUTA → MUTE

### 3 OUT A/B

Press these buttons once a time along with an IN buttons to select an input source for an output display. i.e. OUTA → IN1 → TAKE or OUTB → IN10 → TAKE.

### 4 IN 1~10

Press these IN buttons to select an input from the 10 input sources.

### 5 +/-

Press these buttons to move up/down under menu selection.

### 6 OK

Press to confirm the selection.

### 7 CANCEL

Press this button to cancel the IN/OUT selection and during any selection under MENU.

### 8 MENU

Press to enter into the menu selection.

### 9 TAKE

Press this button to confirm the selection of an IN and an OUT button. If this button is not pressed the IN & OUT selection will not be executed.

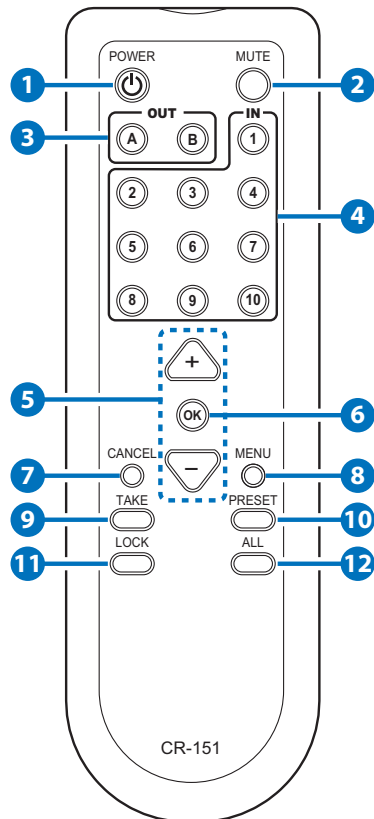



## 10 PRESET

Press this button to recall the preset setting from 1~10. Press and select from IN1~10 then press TAKE to confirm the recall selection or press CANCEL to exit the selection. To reset the Preset setting, enter into menu and select Preset setting from IN1~10 then press OUTA and select an input from IN1~10 then press OUTB and select an input from IN1~10 again and press ENTER to confirm the selection. eg. To preset 2's figure, MENU → ENTER → Matrix Preset → ENTER → Preset2 → IN2 → OUTA → IN8 → OUTB → IN7 → ENTER

## 11 LOCK

Press this button to lock all button functions on the panel to unlock, press the button and hold for 3 seconds.

## 12 ALL

Press this button to select all outputs to display with an input source. e.g. To select all output with input source 3. ALL → IN3

## 6.4 OSD Menu

Main Menu	Sub Menu	Description	Default
EDID Mode	All	All Input port is using same EDID. In menu "EDID All", can select suitable EDID.	All
	Appoint	Each Input port can select individual EDID. In menu "EDID IN1~10" select suitable EDID.	
	Exit		
EDID All	Sink A	Copy Output A display EDID	8/2D/ PCM/1080p
	Sink B	Copy Output B display EDID	
	8/2D/ PCM/720p	Standard EDID, Content: deep color/2D3D/audio/ native resolution	
	8/2D/PCM/ AC3/720p	Standard EDID, Content: deep color/2D3D/audio/ native resolution	
	8/2D/ PCM/1080p	Standard EDID, Content: deep color/2D3D/audio/ native resolution	
	8/2D/PCM/ AC3/1080p	Standard EDID, Content: deep color/2D3D/audio/ native resolution	

Main Menu	Sub Menu	Description	Default
	8/2D/ PCM/4K2K	Standard EDID, Content: deep color/2D3D/audio/ native resolution	
	8/2D/PCM/ AC3/4K2K	Standard EDID, Content: deep color/2D3D/audio/ native resolution	
	8/2D/PCM/ Y420	Standard EDID, Content: deep color/2D3D/audio/ native resolution	
	8/2D/PCM/ AC3/Y420	Standard EDID, Content: deep color/2D3D/audio/ native resolution	
	Exit		
EDID IN1	Same EDID All	Select Input 1's EDID	Same EDID All
EDID IN2	Same EDID All	Select Input 2's EDID	Same EDID All
EDID IN3	Same EDID All	Select Input 3's EDID	Same EDID All
EDID IN4	Same EDID All	Select Input 4's EDID	Same EDID All
EDID IN5	Same EDID All	Select Input 5's EDID	Same EDID All
EDID IN6	Same EDID All	Select Input 6's EDID	Same EDID All
EDID IN7	Same EDID All	Select Input 7's EDID	Same EDID All
EDID IN8	Same EDID All	Select Input 8's EDID	Same EDID All

Main Menu	Sub Menu	Description	Default
EDID IN9	Same EDID All	Select Input 9's EDID	Same EDID All
EDID IN10	Same EDID All	Select Input 10's EDID	Same EDID All
Matrix Preset	Preset 1	IN/OUT default No.1	A=1 , B=1
	Preset 2	No.2	A=1 , B=1
	Preset 3	No.3	A=1 , B=1
	Preset 4	No.4	A=1 , B=1
	Preset 5	No.5	A=1 , B=1
	Preset 6	N0.6	A=1 , B=1
	Preset 7	N0.7	A=1 , B=1
	Preset 8	N0.8	A=1 , B=1
	Preset 9	N0.9	A=1 , B=1
	Preset 10	N0.10	A=1 , B=1
	Exit		

**To reset the Preset setting, select a Preset from 1~10 then press OUTA and select an input from 1~10 then press OUTB and select an input from 1~10 again and press ENTER to confirm the selection.**

HDCP Input	IN1 Standard/Apple	Set IN1 in Apple/Standard mode	Standard
	IN2 Standard/Apple	Set IN2 in Apple/Standard mode	Standard
	IN3 Standard/Apple	Set IN3 in Apple/Standard mode	Standard
	IN4 Standard/Apple	Set IN4 in Apple/Standard mode	Standard
	IN5 Standard/Apple	Set IN5 in Apple/Standard mode	Standard

Main Menu	Sub Menu	Description	Default
	IN6 Standard /Apple	Set IN6 in Apple/ Standard mode	Standard
	IN7 Standard /Apple	Set IN7 in Apple/ Standard mode	Standard
	IN8 Standard /Apple	Set IN8 in Apple/ Standard mode	Standard
	IN9 Standard /Apple	Set IN9 in Apple/ Standard mode	Standard
	IN10 Standard /Apple	Set IN10 in Apple/ Standard mode	Standard
	Exit		
Network Setup	IP Mode	DHCP , Static	DHCP
	IP	Setup Static IP	192.168.1.50
	Mask	Setup Static Netmask	255.255.255.0
	Gate	Setup Static Gateway	192.168.5.254
	Do Re-Link	Re-Link. <b>After setup Network, the system need to re-link</b>	---
	Exit		
Network Status	Link	Network status DHCP,Static or Not Linked	---
	IP	Get IP	---
	Mask	Get Netmask	---
	Gate	Get Gateway	---
	MAC	System MAC Address	---
	Exit		



Main Menu	Sub Menu	Description	Default
Source Detection <i>(Detect Source's 5V-pin only)</i>	IN1 On/Off , IN2 On/Off	IN1 , IN2 detect source with/without the signal	---
	IN3 On/Off , IN4 On/Off	IN3 , IN4 detect source with/without the signal	
	IN5 On/Off , IN6 On/Off	IN5 , IN6 detect source with/without the signal	
	IN7 On/Off , IN8 On/Off	IN7 , IN8 detect source with/without the signal	
	IN9 On/Off , IN10 On/Off	IN9 , IN10 detect source with/without the signal	
	Exit		
Sink A Info	Type, Manuf.	Detect and Analysis Output A display's EDID  Content: type(HDMI/ DVI/VGA), Manufactory/Model number	---
	Native	Content: native resolution	
	Video Format	Content: deep color, 2D or 3D, 4K2K	
	Audio Format	Content: PCM, BitStream, HBR	
	Exit		
Sink B Info	Same Sink A Info	Detect and Analysis Output B display's EDID	---



Main Menu	Sub Menu	Description	Default
Firmware	FW Version	Display the model number and FW version	---
	Update	FW Update	
	Exit		
Factory Reset	Do Reset	Do system Reset	---
	Exit		
Exit			

## 6.5 RS-232 Protocols

Switch			Remote Control	
PIN	Assignment		PIN	Assignment
1	NC		1	NC
2	TxD		2	RxD
3	RxD		3	TxD
4	NC		4	NC
5	GND		5	GND
6	NC		6	NC
7	NC		7	NC
8	NC		8	NC
9	NC		9	NC

Baud Rate: 115200bps

Data bit: 8 bits

Parity: None

Flow Control: None

Stop Bit: 1

## 6.6 IR Pin Definitions

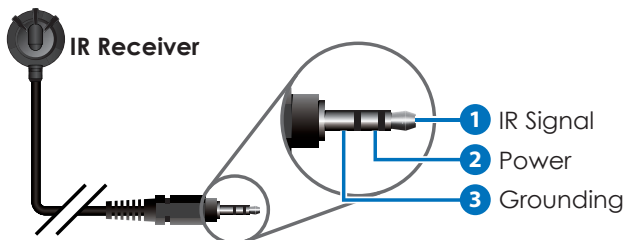



## 6.7 IP Searching Software Application and Installation

Please download the software from [www.cypress.com.tw](http://www.cypress.com.tw) with file name CDPS V2.000 and save it in a directory where you may use it later.

Connect the Control System with PC/Laptop through the Ethernet port through an active network system and open the CDPS V2.000 application. Click on Find Devices on Network and a list of the devices connected to the Control System will show up.

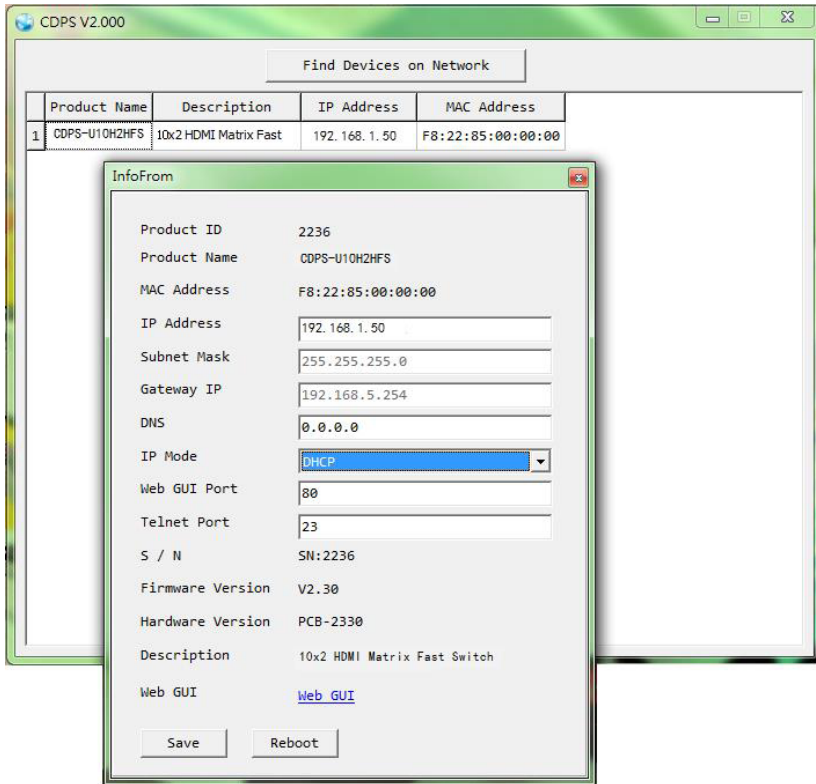

Then user may use the IP Address to find the control device through Telnet, WebGUI or even RS-232/Hyper Terminal tools.

## 6.8 Telnet & RS-232 Commands

Command Name	Description	Description of parameter
P0	Power Off (Standby)	NONE
P1	Power On	NONE
A N	Set Output A Source	N=1-10
B N	Set Output B Source	N=1-10
I N	Set All Outputs Source	N=1-10
IPCONFIG	Display The Current IP Configure	NONE
SIPADDR XXX.XXX.XXX.XXX	Set Ethernet IP Address	XXX=0~255
SNETMASK XXX.XXX.XXX.XXX	Set Ethernet Net Mask	XXX=0~255
SGATEWAY XXX.XXX.XXX.XXX	Set Ethernet Gateway	XXX=0~255
HTTPPORT N	Set Http Port Number	N=0~65535
RSTIP	IP Configuration Reset To <DHCP>	NONE
EDIDMODE	Show EDID MODE	NONE
EDIDMODE N	Set EDID Mode	N=0(Appoint), 1(All)
EDIDALL	Show EDID Mode Source For All	NONE
EDIDALL N	Set EDID Mode Source For All	N=1-10
EDIDIN	Show Input EDID Source	NONE
EDIDIN N1	Show Input N1 EDID Source	N1=1-10
EDIDIN N1 N2	Set Input N1 EDID Source	N1=1-10 N2=1-10

Command Name	Description	Description of parameter
HDCPIN	Input HDCP Status	NONE
HDCPIN <i>N1</i>	Show Input <i>N1</i> HDCP Status	<i>N1</i> =1-10
HDCPIN <i>N1 N2</i>	Set Input <i>N1</i> HDCP On/Off	<i>N1</i> =1-10 <i>N2</i> =0(OFF), 1(ON)
PRESET	Show All Preset Configure	NONE
PRESET <i>N1</i>	Set Preset <i>N1</i> Source to Outputs	<i>N1</i> =1-10
PRESET <i>N1 N2</i>	Set Preset <i>N1</i> Configure	<i>N1</i> =1-10 <i>N2</i> =AXBX ( <i>X</i> =01-10,0M)
SOURCEDET	Show All Input Signal	NONE
SOURCEDET <i>N1</i>	Show Input <i>N1</i> Signal	<i>N1</i> =1-10
SINKINFO	Show Output Information	NONE
INNAME	Show Input Name	NONE
INNAME <i>N1 N2</i>	Set Input <i>N1</i> Name	<i>N1</i> =1-10 <i>N2</i> =ABCDEFGH(Max Length=8)
OUTNAME	Show Output Name	NONE
OUTNAME <i>N1 N2</i>	Set Output <i>N1</i> Name	<i>N1</i> =1-2 <i>N2</i> =ABCDEFGH(Max Length=8)
VER	Show Unit Firmware Version	NONE
REBOOT	System Reboot	NONE
HELP (?)	Show Command List	NONE
HELP <i>N</i>	Show Descript Of Command	<i>N</i> : COMMAND NAME

Command Name	Description	Description of parameter
FADEFAULT	All Configure Set To Factory Default	NONE

**Note:** All the RS-232 command will be not executed unless followed with a carriage return. All commands are case-sensitive.

## 6.9 Telnet Control

To access the telnet control in Windows 7, click on 'Start' menu and type "cmd" in the Search field then press enter.

Under Windows XP go to the 'Start' menu and click on "Run", type "cmd" and press enter.

Under Mac OS X, go to Go → Application → Utilities → Terminal

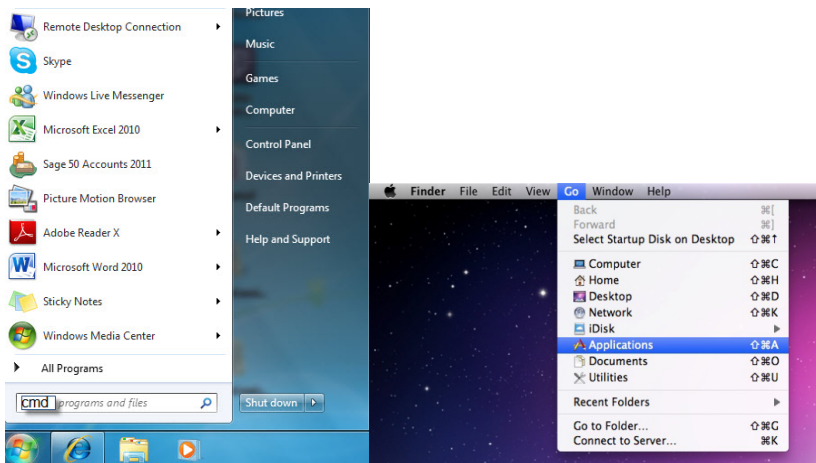

Once in the command line interface (CLI) type "telnet", then the IP address of the unit and hit enter.

```
Microsoft Windows [Version 6.1.7601]
Copyright (c) 2009 Microsoft Corporation. All rights reserved.

C:\Users\Administrator>telnet 192.168.1.50
```



Type HELP or ? to bring out all the commands.

```
Welcome to TELNET.
>??
P0      : POWER OFF
P1      : POWER ON
IPCONFIG : DISPLAY THE CURRENT IPCONFIG
SIPADDR : SET ETHERNET IP ADDRESS
SNETMASK : SET ETHERNET NETMASK
SGATEWAY : SET ETHERNET GATEWAY
HTTPORT  : SET HTTP PORT NUMBER
TELNETPORT : SET TELNET PORT NUMBER
RSTIP    : IP CONFIGURATION RESET TO <DHCP>
A        : SET OUTPUT A SOURCE
B        : SET OUTPUT B SOURCE
I        : SET ALL OUTPUTS SOURCE
EDIDMODE : EDID MODE
EDIDALL  : EDID MODE SOURCE FOR ALL
EDIDIN   : INPUT EDID SOURCE
HDCPIN   : INPUT HDCP STATUS
PRESET   : MATRIX PRESET CONFIGURATION
SOURCEDET : SOURCE SIGNAL DETECT <ON/OFF>
SINKINFO : SINK INFORMATION
INNAME   : INPUT NAME
OUTNAME  : OUTPUT NAME
UER      : SHOW UNIT FIRMWARE VERSION
REBOOT   : SYSTEM REBOOT
?        : SHOW DESCRIPT OF COMMAND
HELP     : SHOW DESCRIPT OF COMMAND
FAEFAULT : ALL CONFIGURE SET TO FACTORY DEFAULT
>_
```

**Note:** All the commands will be not executed unless followed by a carriage return. Commands are case-insensitive. If the IP is changed then the IP Address required for Telnet access will also change accordingly.



## 6.10 WebGUI Control

On a PC/Laptop that is connected to an active network system, open a web browser and type device's IP address (available inside the OSD menu) on the web address entry bar. The browser will display device's Status, IO Status, Matrix Control, Settings and Network Configuration control pages for users to control.

Click on Status for input and output and Preset selection.

Click on IO Status to view connection status and output EDID information and to rename input and output ports.

## Matrix Control

EDID

EDID Mode **ALL** ▼

EDID ALL 8/2D/PCM/1080p ▼

**Factory Reset**

Status | IO Status | **Matrix Control** | Settings | Network Configuration

Click on Matrix Control to set the EDID mode for each and all inputs.

## Settings

HDCP Control

INPUT 1	HDCP Enable	▼
INPUT 2	HDCP Enable	▼
INPUT 3	HDCP Enable	▼
INPUT 4	HDCP Enable	▼
INPUT 5	HDCP Enable	▼
INPUT 6	HDCP Enable	▼
INPUT 7	HDCP Enable	▼
INPUT 8	HDCP Enable	▼
INPUT 9	HDCP Enable	▼
INPUT 10	HDCP Enable	▼

Preset Configuration

PRESET 1:	OUTPUT A	Input 1	▼	OUTPUT B	Input 1	▼
PRESET 2:	OUTPUT A	Input 1	▼	OUTPUT B	Input 2	▼
PRESET 3:	OUTPUT A	Input 1	▼	OUTPUT B	Input 3	▼
PRESET 4:	OUTPUT A	Input 1	▼	OUTPUT B	Input 4	▼
PRESET 5:	OUTPUT A	Input 1	▼	OUTPUT B	Input 5	▼
PRESET 6:	OUTPUT A	Input 9	▼	OUTPUT B	Input 6	▼
PRESET 7:	OUTPUT A	Input 1	▼	OUTPUT B	Input 7	▼
PRESET 8:	OUTPUT A	Input 1	▼	OUTPUT B	Input 8	▼
PRESET 9:	OUTPUT A	Input 1	▼	OUTPUT B	Input 9	▼
PRESET 10:	OUTPUT A	Input 1	▼	OUTPUT B	Input 10	▼

Status | IO Status | Matrix Control | **Settings** | Network Configuration

Click on Settings to set each input's HDCP Control and Preset Configuration.

### Network Configuration

MAC Address	F8-22-85-00-03-C9
Address Type	DHCP
IP Address	192.168.5.131
Net Mask	255.255.255.0
Default Gateway	192.168.5.254
Http Port	80
Telnet Port	23

Save

Status   IO Status   Matrix Control   Settings   **Network Configuration**

Click on Network Configuration to set the device's IP configuration. Once the changes are saved the system will reset the IP address on device automatically and user will need to re-enter the IP address to continue the WebGUI function.

## 7. CONNECTION DIAGRAM

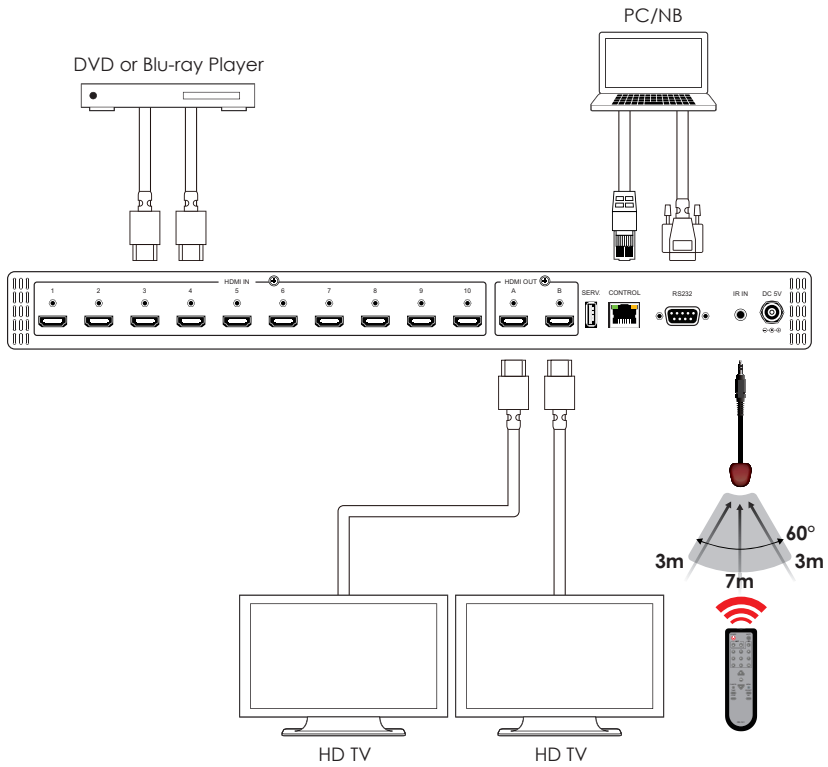

## 8. SPECIFICATIONS

<b>Video Bandwidth</b>	300MHz / 9Gbps
<b>Input Ports</b>	10 x HDMI, 1 x IR Extender, 1 x RJ-45 (Control), 1 x RS-232, 1 x USB (Firmware update only)
<b>Output ports</b>	2 x HDMI
<b>Resolution</b>	HD: 480i~1080p@24/50/60, 4K2K@24/25/30 & 4K2K@60 YUV_420
<b>HDMI I/O Cable Length</b>	Up to 10M at 1080p@ 8/12 bits or up to 5M at 4K2K
<b>Power Supply</b>	5V DC/2.6A (US/EU standards, CE/FCC/UL certified)
<b>ESD Protection</b>	Human body model: ±8kV (air-gap discharge) ±4kV (contact discharge)
<b>Dimensions</b>	438mm (W) x 269mm (D) x 44mm (H)/ Jacks Excluded 482mm (W) x 276mm (D) x 52mm (H)/ Jacks Included
<b>Weight</b>	2854g
<b>Chassis Material</b>	Metal
<b>Silkscreen Color</b>	Black
<b>Operating Temperature</b>	0°C~40°C / 32°F ~ 104°F
<b>Storage temperature</b>	-20°C~60°C / -4°F ~ 140°F
<b>Relative Humidity</b>	20~90% RH (no condensation)
<b>Power Consumption</b>	8.3w (Max)



DVI and HDMI Supported Resolutions	Input	Output
640x480@60/72/75	✓	✓
720x480@60	✓	✓
720x576p@50	✓	✓
800x600@60/72/75	✓	✓
1024x768@60/70/75	✓	✓
1280x720@50/60	✓	✓
1280x720p@60	✓	✓
1280x768@60	✓	✓
1280x800@60	✓	✓
1280x1024@60	✓	✓
1360x768@60	✓	✓
1600x1200@60	✓	✓
1920x1080i@50/60	✓	✓
1920x1080p@24/25/30/50/60	✓	✓
1920x1200@60(RB)	✓	✓
3840x2160@24/25/30	✓	✓
3840x2160@50/60 YUV420	✓	✓
4096x2160@24/25/30	✓	✓
4096x2160@50/60 YUV420	✓	✓





**CYPRESS TECHNOLOGY CO., LTD**

Home page: <http://www.cypress.com.tw>

MPM-CDPSU10H2HFS