



CPLUS-442CVL

4×6 HDMI and HDBaseT Matrix



Operation Manual

DISCLAIMERS

The information in this manual has been carefully checked and is believed to be accurate. Cypress Technology assumes no responsibility for any infringements of patents or other rights of third parties which may result from its use.

Cypress Technology assumes no responsibility for any inaccuracies that may be contained in this document. Cypress also makes no commitment to update or to keep current the information contained in this document.

Cypress Technology reserves the right to make improvements to this document and/or product at any time and without notice.

COPYRIGHT NOTICE

No part of this document may be reproduced, transmitted, transcribed, stored in a retrieval system, or any of its part translated into any language or computer file, in any form or by any means—electronic, mechanical, magnetic, optical, chemical, manual, or otherwise—without express written permission and consent from Cypress Technology.

© Copyright 2016 by Cypress Technology.

All Rights Reserved.

TRADEMARK ACKNOWLEDGMENTS

All products or service names mentioned in this document may be trademarks of the companies with which they are associated.





SAFETY PRECAUTIONS

Please read all instructions before attempting to unpack, install or operate this equipment and before connecting the power supply.

Please keep the following in mind as you unpack and install this equipment:

- Always follow basic safety precautions to reduce the risk of fire, electrical shock and injury to persons.
- To prevent fire or shock hazard, do not expose the unit to rain, moisture or install this product near water.
- Never spill liquid of any kind on or into this product.
- Never push an object of any kind into this product through any openings or empty slots in the unit, as you may damage parts inside the unit.
- Do not attach the power supply cabling to building surfaces.
- Use only the supplied power supply unit (PSU). Do not use the PSU if it is damaged.
- Do not allow anything to rest on the power cabling or allow any weight to be placed upon it or any person walk on it.
- To protect the unit from overheating, do not block any vents or openings in the unit housing that provide ventilation and allow for sufficient space for air to circulate around the unit.

REVISION HISTORY

VERSION NO.	DATE (DD/MM/YY)	SUMMARY OF CHANGE
VS1	24/10/16	Updated text/diagrams
VS2	18/04/17	Corrections to section 6.4



CONTENTS

1. Introduction	1
2. Applications	1
3. Package Contents	1
4. System Requirements	2
5. Features	2
6. Operation Controls and Functions	3
6.1 Front Panel	3
6.2 Rear Panel	4
6.3 Side Panel	6
6.4 Remote Control	7
6.5 OLED Menu	8
6.6 IR Cable Pin Assignment	9
6.7 RS-232 Protocol	9
6.8 RS-232 and Telnet Commands	10
6.8.1 Command Syntax	10
6.8.2 Full Command List	11
6.9 Telnet Control	19
6.10 WebGUI Control	21
6.10.1 Video Switch	23
6.10.2 Zone Video Pairing	26
6.10.3 EDID Settings	27
6.10.4 HDBaseT & H/W Info	29
6.10.5 User Config	30
6.10.6 System Settings	30
6.10.7 Logout	31
7. Connection Diagram	32
8. Specifications	33
8.1 Technical Specifications	33
8.2 Supported Video Formats	34
8.2.1 Supported HDMI Resolutions	34



8.2.2 Maximum HDMI Cable Length.....	34
8.3 Supported Audio Formats	35
8.3.1 Linear PCM Audio	35
8.3.2 Compressed Audio.....	35
8.4 Category Cable Specifications.....	36
8.5 HDBaseT Features.....	36
9. Acronyms	37



1. INTRODUCTION

This 4×6 HDMI/HDBaseT Matrix supports routing and transmission of video (resolutions up to 4K@60Hz w/ HDMI 2.0 & HDCP 2.2) and audio (multi-channel digital/stereo analog) while providing flexible control via IR, RS-232, Telnet or WebGUI. As many as four HD sources may be routed to any of six destinations via a single Cat.5e/6/7 cable (up to 60m at 1080p or up to 40m at 4K@30Hz). The two HDMI 2.0 outputs support transmission of 6G UltraHD HDMI sources (up to 4K@60Hz, 4:4:4) from any HDMI input or they can mirror any of the HDBaseT outputs for local monitoring. 3D video is also supported when compatible sources and displays are connected. This product supports passing 7.1 channel LPCM digital audio as well as advanced bitstream and HD bitstream audio formats. Additionally, four analog audio outputs are available to provide stereo breakout audio from the associated HDBaseT output (LPCM 2.0 sources only).

The Power over HDBaseT (PoH) function can power compatible receivers, providing greater flexibility in your installations. Control is via manual selection buttons, WebGUI, Telnet, RS-232 or IR remote.

2. APPLICATIONS

- Full audio/video matrix systems
- Residential AV matrix installations
- Commercial AV matrix installations
- Security systems
- University lecture hall systems
- Retail installation systems

3. PACKAGE CONTENTS

- 1× 4 by 6 HDMI/HDBaseT Matrix
- 1× Remote Control (CR-163)
- 2× IR Extender Cable
- 2× IR Blaster Cable
- 1× 24V/6.25A DC Power Adaptor
- 1× Power Cord



- 1× Rack Ear Set
- 1× Operation Manual

4. SYSTEM REQUIREMENTS

- HDMI or DVI source equipment such as media players, video game consoles, set-top boxes, PCs or laptops. DVI equipped source devices must be connected via DVI to HDMI cables/adapters
- HDMI receiving equipment such as HDTVs, monitors or audio amplifiers
- The use of industry standard Cat.6, Cat.6a or Cat.7 cable is highly recommended
- The use of "Premium High Speed HDMI" cables is highly recommended

5. FEATURES

- HDMI 2.0, HDCP 1.4 and HDCP 2.2 compliant
- Routes four HDMI sources to six displays using four HDBaseT outputs and two independent or mirrored HDMI outputs
- HDBaseT feature support: High-Definition video and audio, PoH (Power over HDBaseT) and control (Bi-directional IR & RS-232 pass-through)
- Supported HDBaseT resolutions: VGA~WUXGA, 480i~1080p, 4K@24/25/30Hz (RGB, YUV 4:4:4 & YUV 4:2:2) & 4K@60Hz (YUV 4:2:0) dependent upon the output display's EDID settings
- Supports HDMI output resolutions up to 4K@60Hz (RGB/YUV 4:4:4)
- Supports automatic 4K@60Hz RGB/YUV 4:4:4 to YUV 4:2:0 conversion for HDBaseT outputs
- 4K@30Hz signals can be transmitted up to 35m via Cat.5e/6 and up to 40m via Cat.6a/7
- Supports pass-through of all standard digital audio formats: LPCM 2.0/5.1/7.1, bitstream, and HD bitstream
- Supports Digital to Analog Conversion (DAC)
- Advanced internal and external EDID management with 4 sets of configurable EDID settings

- Bi-directional IR support over HDBaseT
- Control via front panel controls, Ethernet (Telnet & WebGUI), RS-232, & IR remote
- 1U rack mounted design

6. OPERATION CONTROLS AND FUNCTIONS

6.1 Front Panel

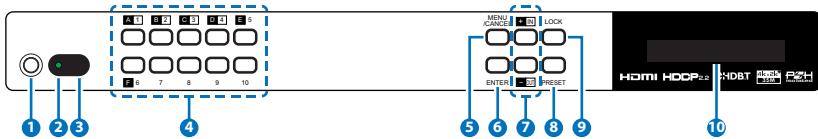

- 1 POWER:** Press this button to power the unit on or place it into stand-by mode.

Note: Network functionality and PoH remain active when the unit is in stand-by mode.

- 2 POWER LED:** This LED will illuminate GREEN to indicate the unit is on and receiving power. When the unit is in stand-by mode the LED will illuminate RED.
- 3 IR WINDOW:** Accepts IR signals from the included IR remote for control of this unit only.
- 4 OUTPUT A~F, INPUT 1~4 & Number 1~10:** Press the "OUT" button to enter output selection mode. Next, press the output keys (A~F) of the outputs you wish to route a source to (they will flash to indicate selection). Next, press the "IN" key followed by the input (1~4) you wish to route to the selected outputs. Finally, press "ENTER" to confirm your selection and execute the routing change.

For example, if you wish to display input 1 on outputs A~D then the following sequence of button presses should be performed: OUT → A, B, C, D → IN → 1 → ENTER

When directly entering Ethernet address information into the unit all 10 buttons are used to represent the numbers from 0 to 9 (button 10 = 0) to make number entry more streamlined.

- 5 MENU/CANCEL:** Press the "MENU/CANCEL" button to enter the



OLED menu, or to back out from menu items. For a description of the menu tree, please refer to section 6.6.

- 6 ENTER:** Press this button to confirm selections.
- 7 +/-/IN:** Within the menu, this button moves you up within the menu tree. Otherwise, in routing mode, this button allows you to make your input source selection.
-/OUT: Within the menu, this button moves you down within the menu tree. Otherwise, this button starts routing mode and allows you to begin your output destination selections.
- 8 PRESET:** Press this button to recall saved presets. A maximum of 8 presets can be stored in the unit. Presets are created and stored via the WebGUI. Please refer to section 6.10.1 for advanced preset settings.
- 9 LOCK:** Press and hold this button for 3 seconds to lock/unlock all buttons on the front panel. The OLED will display an “L” in the upper right corner to indicate the front panel is locked.
- 10 OLED WINDOW:** Displays the unit's menu, settings and information.

6.2 Rear Panel

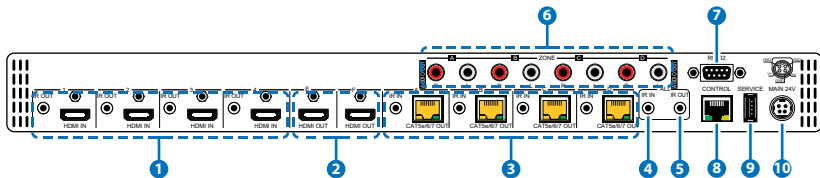

- 1 HDMI IN & IR OUT 1~4:** Connect up to 4 source devices to the HDMI ports using appropriate quality HDMI cables. Input source devices include Blu-ray players, set-top boxes, game systems and so on. These inputs are DVI-D compliant (with the use of DVI to HDMI adapters or cables). Attach IR blasters to the IR Out ports to transmit the IR signals received from connected HDBaseT Receivers. The IR signal routing follows the HDMI signal routing.

Note: The use of “Premium High Speed HDMI” cables is highly recommended.

- 2 HDMI OUT E & F:** Connect up to 2 HDMI displays using these HDMI output ports. These two HDMI ports can be either independent

high bandwidth (6G) outputs, or they can be configured to mirror two of the HDBaseT outputs for local monitoring or recording purposes.

Note: 4K signals with HDR (High Dynamic Range) or Deep Color are supported by the 2 HDMI output ports, however they are not supported by the HDBaseT outputs due to bandwidth limitations. If your HDR source needs to be output over the HDBaseT outputs please remember to disable the HDR support on your source device or use a non-HDR supporting EDID.

- 3 CAT5e/6 OUT & IR IN A~D:** Connect the Cat.5e/6 outputs via an appropriate cable to the input ports of compatible HDBaseT receivers for HDMI audio/video and IR/RS-232 control signal transmission. In order for an IR signal to be transmitted along with the HDMI signal an IR extender must be connected to the associated IR In port. IR signals coming back from the connected HDBaseT receiver can be used to control the matrix remotely and will also be broadcast from IR blasters connected to the appropriate IR Out/All IR Out ports.

Note: 4K signals with HDR (High Dynamic Range) or Deep Color are supported by the 2 HDMI output ports, however they are not supported by the HDBaseT outputs due to bandwidth limitations. If your HDR source needs to be output over the HDBaseT outputs please remember to disable the HDR support on your source device or use a non-HDR supporting EDID.

- 4 IR IN (ALL):** Connect an IR extender to this port for IR signal reception. All IR signals received will be broadcast by all IR blasters connected to the matrix or connected HDBaseT receivers. Please ensure that the remote being used is within direct line-of-sight of the IR extender.
- 5 IR OUT (ALL):** Connect an IR Blaster to this port to broadcast IR signals. All IR signals received by any IR extenders connected to the matrix or HDBaseT receivers will be broadcast. Please place the IR Blaster in direct line-of-sight of the equipment to be controlled.
- 6 AUDIO OUT A~D:** Four sets of stereo analog audio outputs. These audio ports mirror the audio output from the associated HDBaseT output (LPCM 2.0 sources only).
- 7 RS-232:** Connect directly to your PC/laptop to send RS-232 commands to control the unit (refer to section 6.7).

- 8 **CONTROL:** Connect directly, or through a network switch, to your PC/laptop to control the unit via Telnet/WebGUI.
- 9 **SERVICE:** Used for firmware service updates in the field via USB thumb drive. After connecting a USB thumb drive containing appropriate firmware, please select navigate via the front panel menu to 5-Firmware → 2-Update → YES to begin the firmware update.
- 10 **MAIN 24V:** Plug the 24V DC power adapter into the unit and connect it to an AC wall outlet for power.

6.3 Side Panel

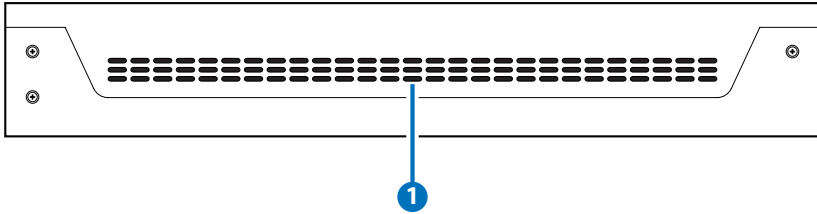

- 1 **FAN VENT:** These are air ventilation areas. DO NOT block these areas or cover them with any objects. Please allow adequate space around the unit for air circulation.

6.4 Remote Control

- 1 **POWER:** Press to power the unit on or place it into stand-by mode.
- 2 **LOCK:** Press to lock/unlock the front panel of the matrix unit.
- 3 **MUTE:** No function.
- 4 **IN 1~4 & OUT A~F:**

[Local matrix control]: When controlling the unit directly. Input selection from 1~4 and output selection from A~F (refer to section 6.1).

[Zone A/V Pairing]: When controlling the unit via an HDBaseT receiver in a remote location. Pressing buttons 1~4 will switch to the A/V source assigned to the number depending on your current zone. These assignments are configured via the WebGUI (refer to section 6.10.2).

- 5 **MENU/CANCEL:** Press the “MENU/CANCEL” button to enter the OLED menu, or to back out from menu items.
 - 6 **PRESET:** Recall matrix presets. The presets are configured within the WebGUI.
 - 7 **+/IN:** Within the menu, this button moves you up within the menu tree. Otherwise, in routing mode, this button allows you to make your input source selection.
- /OUT:** Within the menu, this button moves you down within the menu tree. Otherwise, this button starts routing mode and allows you to begin your output destination selections.
- ◀/VOL- & ▶/VOL-:** No function.

ENTER: Press this button to confirm selections.

Note: This remote control is designed for the full family of matrix products. Some functions are not available on all units.

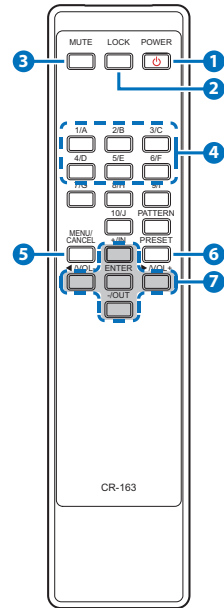

6.5 OLED Menu

1ST LEVEL	2ND LEVEL	3RD LEVEL
EDID	EDID Mode	All
		Independent
	EDID Select	All
		1~6 (Default EDID settings)
		7~12 (Sink's EDID settings)
	13~16 (User's EDID settings)	
Network	Link Status (Idle)	
	IP Address	
	Subnet Mask	
	Gateway Address	
	MAC Address	
Network (Cont.)	DHCP mode	On
		Off
HDMI Mirroring	Output E	
	Output F	
Factory Default	Yes	
	No	
Firmware	Version	
	Update	Yes
		No

Note: The model name and IP address will be displayed when the unit is powered on. The netmask and gateway information can be displayed by repeatedly pressing the “+” button on the front panel or remote control unit.

6.6 IR Cable Pin Assignment

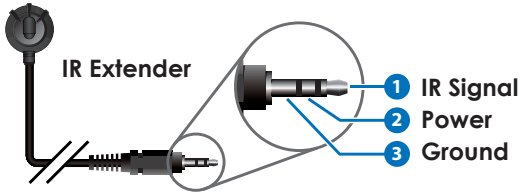
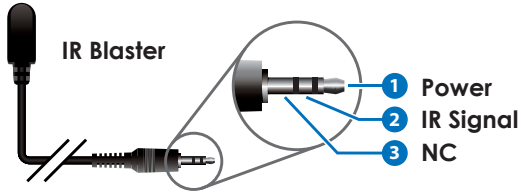

6.7 RS-232 Protocol

MATRIX	
Pin	Assignment
1	NC
2	TX
3	RX
4	NC
5	GND
6	NC
7	NC
8	NC
9	NC



REMOTE CONTROLLER	
Pin	Assignment
1	NC
2	RX
3	TX
4	NC
5	GND
6	NC
7	NC
8	NC
9	NC

Baud Rate: 115200bps
 Data Bits: 8
 Parity: None
 Flow Control: None
 Stop Bits: 1



6.8 RS-232 and Telnet Commands

6.8.1 Command Syntax

The RS-232/Telnet command structure for this unit is both flexible and powerful, and allows for a parameter to be set across multiple ports simultaneously within a single command transmission. This section will detail the command syntax used to send both simple (single port) commands as well as the more complex commands.

The following multi-function syntax is specifically for use with these commands: "HDMI_Out" and "HDBT_Out". "ZoneAvPair" has a special structure that will be explained separately. All other commands must be sent within discrete transmissions.

- **Basic Command Format**

Use this syntax to set or change a single parameter for a single input/output port.

<Command> {Port} {Parameter [= Value]}

Examples: HDMI_Out F VideoSrc=1

HDBT_Out A VideoSrc=3

- **Basic Command Format (ZoneAvPair)**

The ZoneAvPair command requires multiple variables to define the location of the slot's value to adjust. This command only accepts 2 possible parameters: "VideoSrc" and "Load". Use the following syntax to set or change a single parameter for a single slot assigned to an HDBaseT or HDMI output port.

ZoneAvPair HDBT_Out {Port} Slot {Slot} {Parameter [= Value]}

Examples: ZoneAvPair HDBT_Out B Slot 5 VideoSrc = HDMI_In 2

ZoneAvPair HDMI_Out F Slot 3 Load

- **Multi-Port Command Format**

Use the following syntax to set or change a single parameter for multiple ports. Note that each additional port uses the "+" character for separation. The number of ports allowed in a single command is limited by the number of ports on that specific interface.

<Command> {Port1}+{Port2}+{Etc.} {Parameter [= Value]}

Examples: *HDMI_Out E+F VideoSrc=1*

HDBT_Out A+B+C VideoSrc=3

- **Multi-Slot Command Format (ZoneAvPair)**

The ZoneAvPair command allows for multiple slots on a single HDBaseT or HDMI output to be assigned the same value simultaneously. Use the following syntax to accomplish this. Note that each additional slot uses the “+” character for separation. The number of slots allowed in a single command is limited by the number of slots on that specific interface.

ZoneAvPair HDBT_Out {Port} Slot {Slot1}+{Slot2}+{Etc.} {Param [= Value]}

Example: *ZoneAvPair HDBT_Out B Slot 1+3+5 VideoSrc = HDMI_In 2*

6.8.2 Full Command List

COMMAND	DESCRIPTION
HDMI_Out M VideoSrc=XXX	Set the video source for an HDMI output. M = E~F Available XXX values: HDMI_In n [n = 1~4]
HDMI_Out M VideoSrc=Default	Reset the video source of an HDMI output to the factory default. M = E~F
HDMI_Out M Mirroring=XXX	Set the audio/video mirroring source for an HDMI output. M = E~F Available XXX values: HDBT_Out n [n = A~D]

COMMAND	DESCRIPTION
HDMI_Out M Status	<p>Display the status & properties of an HDMI output including audio/video matrix.</p> <p>M = E~F</p>
HDMI_Out M Name={NameString}	<p>Set the verbose name of an HDMI output. Maximum 32 characters.</p> <p>M = E~F</p> <p>Note: Can only rename one port at a time. Multi-port is not supported.</p>
HDBT_Out M VideoSrc=XXX	<p>Set the video source for an HDBaseT output.</p> <p>M = A~D</p> <p>Available XXX values: HDMI_In n [n=1~4]</p>
HDBT_Out M VideoSrc=Default	<p>Reset the video source of an HDBaseT Tx output to the factory default.</p> <p>M = A~D</p>
HDBT_Out M Status	<p>Display the status & properties of an HDBaseT output including audio/video matrix.</p> <p>M = A~D</p>

COMMAND	DESCRIPTION
HDBT_Out M Name={NameString}	Set the verbose name of an HDBaseT output. Maximum 32 characters. M = A~D Note: Can only rename one port at a time. Multi-port is not supported.
HDMI_In M Status	Display the status of an HDMI input. M = 1~10
HDMI_In M Name={NameString}	Set the verbose name of an HDMI input. Maximum 32 characters. M = 1~4 Note: Can only rename one port at a time. Multi-port is not supported.
SETIP {IP} {Subnet} {Gateway}	Set the IP address, subnet and gateway in Static IP mode. Address format: xxx.xxx.xxx.xxx
RSTIP	Request updated IP information from the DHCP server.
IPCONFIG	Display the current IP configuration.
P0	Enter light stand-by mode. (RS-232, Ethernet and PoH functionality is still active.)
P1	Turn the power on.

COMMAND	DESCRIPTION
P2	Enter deep stand-by mode. (Only RS-232 functionality is still active.)
P?	Report the current power status.
PRESET Save M	Save the current A/V routing as a preset. M = 1~8
PRESET Load M	Load and activate a saved A/V preset. M = 1~8
PRESET Show [M]	List the contents of a stored A/V preset. M = 1~8 (If M is omitted, list all A/V presets.)
PRESET name M={NameString}	Set the verbose name of a preset. Maximum 32 characters. M = 1~8
EDID All=XXX	Set the EDID source for all HDMI input ports. Available XXX values: 1~6 [Factory EDIDs] 7~12 [Connected sink EDIDs] 13~16 [User EDIDs]

COMMAND	DESCRIPTION
EDID HDMI_In M=XXX	Set the EDID source for a single HDMI port. M = 1~4 Available XXX values: 1~6 [Factory EDIDs] 7~12 [Connected sink EDIDs] 13~16 [User EDIDs]
EDID M Name={NameString}	Set the verbose name of a user EDID slot. Maximum 16 characters. M = 13~16
FactoryDefault	Reset all settings to their factory defaults. (Hidden command.)
MAC	Display the MAC address.
?	Display all available commands. (Except hidden commands.)
Help	Display all available commands. (Except hidden commands.)
Ver	Display the firmware version.
ZoneAvPair HDBT_Out M Slot N VideoSrc=XXX	Assign a video source to a Zone A/V Pair slot on an HDBaseT output. M = A~D N = 1~10 Available XXX values: HDMI_In n [n=1~4]

COMMAND	DESCRIPTION
ZoneAvPair HDBT_Out M Slot N Load	Load and activate the contents of a Zone A/V Pair slot on an HDBaseT output. M = A~D N = 1~10
ZoneAvPair HDMI_Out M Slot N VideoSrc=XXX	Assign a video source to a Zone A/V Pair slot on an HDMI output. M = E~F N = 1~10 Available XXX values: HDMI_In n [n=1~4]
ZoneAvPair HDMI_Out M Slot N Load	Load and activate the contents of a Zone A/V Pair slot on an HDMI output. M = E~F N = 1~10

COMMAND	DESCRIPTION
IR_Route HDBT_Out M0 M1 M2	<p>Select the IR source(s) for an HDBaseT output.</p> <p>M0 is the output port index. M1 is the function to use. M2 is the IR input source.</p> <p>M0 = A~D (supports multiple port selection by using "+".)</p> <p>Available M1 values: Add [Add M2 source to M0] Del [Remove M2 source from M0]</p> <p>Available M2 values: IR_InAll [IR In (ALL) input jack] Generator [Internal IR encoder]</p>
IR_Route HDBT_Out M0 Show	<p>Display the current IR source of the HDBaseT output.</p> <p>M0 = A~D (supports multiple port selection by using "+".)</p>

COMMAND	DESCRIPTION
IR_Route IR_Out M0 M1 M2	<p>Select the IR source(s) for an IR Output jack (next to each HDMI input).</p> <p>M0 is the output port index. M1 is the function to use. M2 is the IR input source.</p> <p>M0 = 1~4 (supports multiple port selection by using "+".)</p> <p>Available M1 values: Add [Add M2 source to M0] Del [Remove M2 source from M0]</p> <p>Available M2 values: IR_InAll [IR In (ALL) input jack] Generator [Internal IR encoder]</p>
IR_Route IR_Out M0 Show	<p>Display the current IR source for an IR Output jack (next to each HDMI input).</p> <p>M0 = 1~4 (supports multiple port selection by using "+".)</p>
? {Command}	<p>Display basic instructions for the command.</p>

Note: Commands will not be executed unless followed by a carriage return. Commands are not case-sensitive.

6.9 Telnet Control

Before attempting to use Telnet control, please ensure that both the unit and the PC/Laptop are connected to the same active networks.

To access Telnet in Windows 7, click on the “Start” menu and type “cmd” in the search field, then press “Enter”.

Under Windows XP go to the “Start” menu, click on “Run”, type “cmd” then press “Enter”.

Under Mac OS X, go to Go → Applications → Utilities → Terminal.

See below for reference.

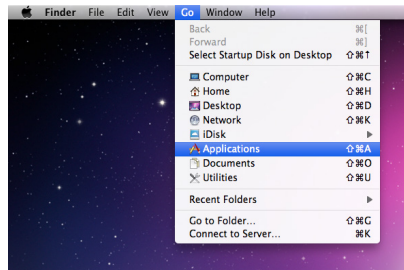
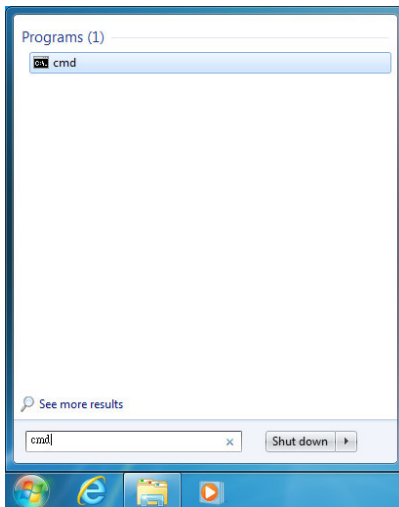



Once in the CLI (Command Line Interface) type “Telnet” followed by the IP address of the unit and “23”, then hit “Enter”.

```
Microsoft Windows [Version 6.1.7601]
Copyright (c) 2009 Microsoft Corporation. All rights reserved.

C:\Users\Administrator>telnet 192.168.5.80 23
```

This will connect us to the unit we wish to control. Type “help” to list the available commands.

```
Help           : Console command online help.
?              : Console command online help.
IPCONFIG       : List IP configurations.
SetIP          : IP configurations.
RSTIP          : Enable DHCP mode.
P0             : Power off with network.
P1             : Power on.
P2             : Power off everything.
P?            : Power off everything.
HDMI_Out       : HDMI output configurations.
HDBT_Out       : HDBT output configurations.
Preset         : Audio/Video preset manipulation.
HDMI_In        : HDMI input configurations.
EDID           : EDID specifier of each input port.
Ver            : Version report.
ZoneAvPair     : Zone Audio/Video pairing configuration.
IR_Route       : IR routing configuring.
```

Note: Commands will not be executed unless followed by a carriage return. Commands are not case-sensitive. If the IP address is changed then the IP address required for Telnet access will also change accordingly.

6.10 WebGUI Control

- **Install the Device Discovery Tool**

Please obtain the Device Discovery software from your authorized dealer and save it in a directory where you can easily find it.

Note: The unit's default IP address is 192.168.1.50

Find Devices on Network			
Product Name	Description	IP Address	MAC Address

Connect the unit and your PC/Laptop to the same active network and execute the Device Discovery software. Click on “Find Devices on Network” and a list of devices connected to the local network will show up indicating their current IP address.

Product ID	
Product Name	
MAC Address	00:00:00:00:00:00
IP Address	<input type="text"/>
Subnet Mask	<input type="text"/>
Gateway IP	<input type="text"/>
DNS	<input type="text"/>
IP Mode	Static
Web GUI Port	80
Telnet Port	80
S / N	
Firmware Version	
Hardware Version	
Description	
Web GUI	Web GUI
Save	Reboot

By clicking on one of the listed devices you will be presented with the network details of that particular device. If you choose, you can alter the static IP network settings for the device, or switch the unit into DHCP mode to automatically obtain proper network settings from a local DHCP server. To switch to DHCP mode, please select DHCP from the IP mode drop-down, then click “Save” followed by “Reboot”.

Once you are satisfied with the network settings, you may use them to connect via Telnet or WebGUI. The network information window provides a convenient link to launch the WebGUI directly.

- Login to the WebGUI

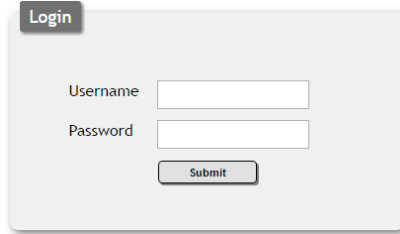

A login form with a grey background and rounded corners. At the top left, there is a dark grey tab labeled "Login". Below the tab, there are two input fields: "Username" and "Password". Each field has a white border and a small arrow on the right side. Below the "Password" field is a "Submit" button with a grey background and a white border.

By default, both the Username and Password are “admin” for the WebGUI. The administrator password can be changed within the “User Config” tab of the WebGUI if desired.

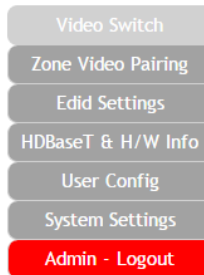

The above function tabs will always display on left side of the WebGUI to aid with navigation.

6.10.1 Video Switch

This page provides video routing settings, preset saving/loading, and I/O renaming options.

- **Output and Input Routing**

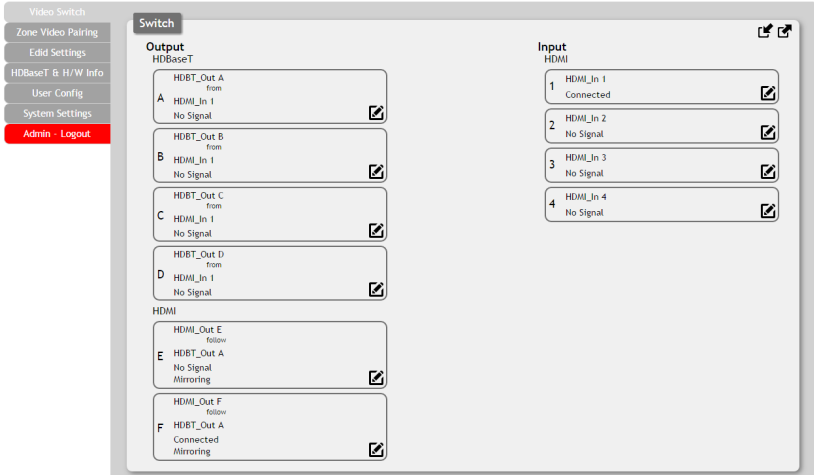

To begin assigning a new video route, please click the button of the HDBaseT output you wish to send video to (e.g. “HDBT_Out A”) and then click on the button of the preferred HDMI input port (e.g. “HDMI_In 1”). If desired, you may select more than one output prior to selecting the input. As you select each button they will change their color to orange. The new route will become active immediately and the routing information displayed on the buttons will change accordingly.

If you need to route an input to multiple outputs, please select all of the appropriate output buttons before selecting the input port.

• Output and Input Naming

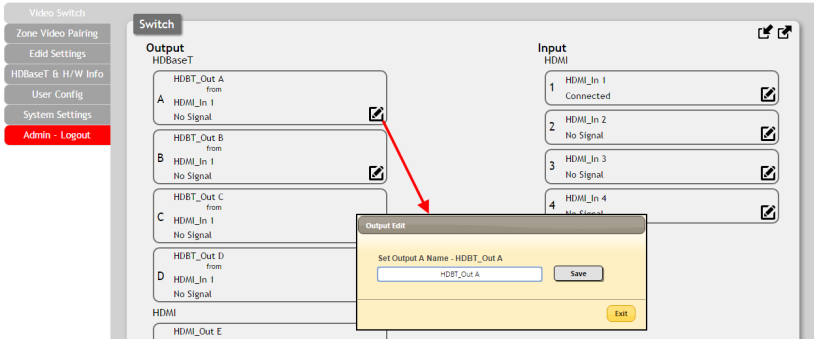

All inputs and outputs can be renamed as required. To rename the HDBaseT output ports and HDMI input ports please click the “edit” icon (✎). Click the “Save” button to confirm the change.

Note: Blank spaces (“ ”) are not allowed in names.

• HDMI Output Setting

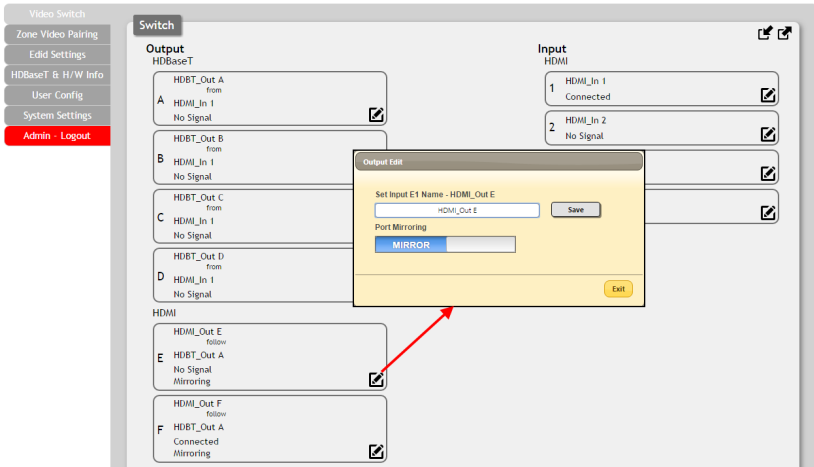

The two HDMI outputs (port E & port F) allow support for the maximum HDMI timing up to 6G (4096×2160@60Hz) and can be used for normal source routing (listed as “Independent” within the WebGUI) and mirroring (listed as “Mirror” within the WebGUI) for local monitoring purposes or zone monitoring (e.g. The HDBaseT output connects to a TV in a remote zone the local HDMI connection goes into an AVR).

Click the “edit” icon (✎) to toggle the HDMI output mode between “Independent” and “Mirror”. When an HDMI port is in “Mirror” mode you can only select HDBaseT outputs as inputs.

• Preset Setting

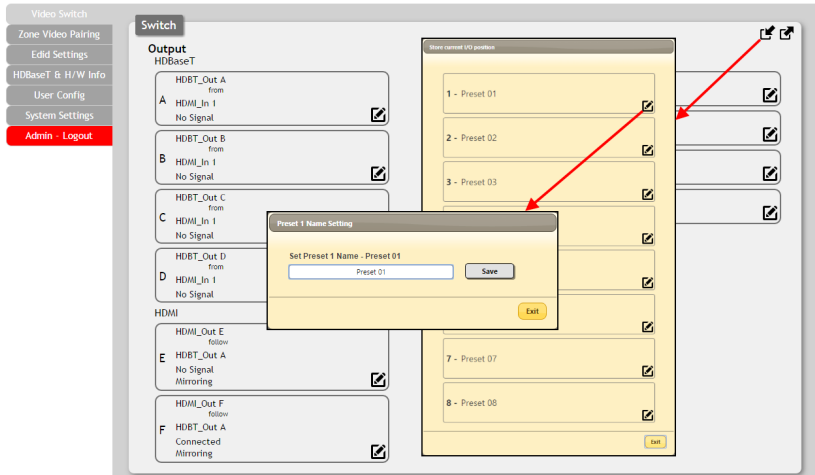

This matrix can store up to eight video and audio routing presets. Presets can be utilized to store multiple different routing states in advance for rapid, hassle-free, recall.

- **Store:** Once you have the matrix set the way you like, you can click the “store” icon (📌) in the upper right corner of the window. You may also name the preset at this stage by selecting the “edit” icon (✎). Click “Save” when you are ready to commit the preset to memory.
- **Recall:** When you wish to load a previously stored setting, please click the “recall” icon (📌) and you will be presented with a choice of the available 8 presets. The preset will load immediately upon selecting the preset.

6.10.2 Zone Video Pairing

The zone video pairing function allows the end user to control the matrix, using the supplied remote control, in a customized manner while in remote rooms (zones) containing an HDBaseT receiver and IR extender.

Each zone can have a different set of video sources assigned to the buttons on the remote control for easy switching. The video routing selection for each of the four HDBaseT outputs need to be set up via the WebGUI in advance.

After setting them all up, the end user just needs to press a number key on the remote control unit once to change the routing status in whichever zone they are currently occupying. The distinct zone pairings can also be activated from within the WebGUI or by using Telnet/RS-232 commands.

- **Quick Button Selection**

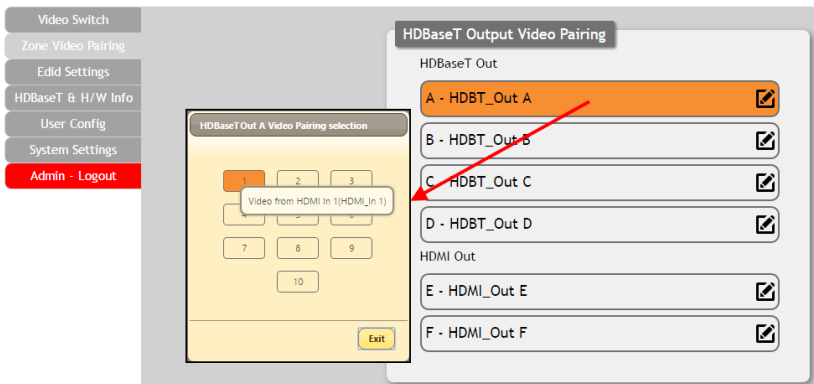

To activate a video pairing from the WebGUI, please select the HDBaseT output port to launch the selection window. The numbers 1~10 correspond to the keys on remote control unit.

• Video Pairing Edit

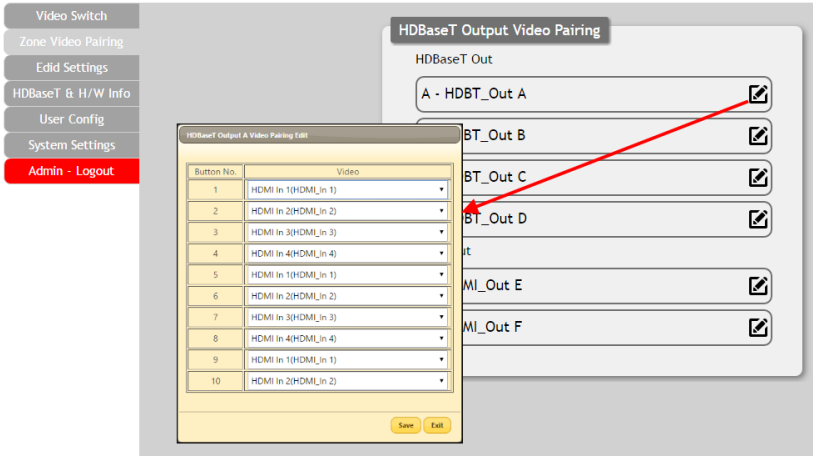

Please click the “edit” icon (✎) to edit the video routing settings. Once you have completed your selections press “Save”.

6.10.3 EDID Settings

This matrix provides the option of six standard EDIDs, six sink sourced EDIDs and four customer uploaded EDIDs that can be assigned to each input port individually. The names of the four customer uploaded EDIDs can be changed if desired.

• Customer EDID Settings

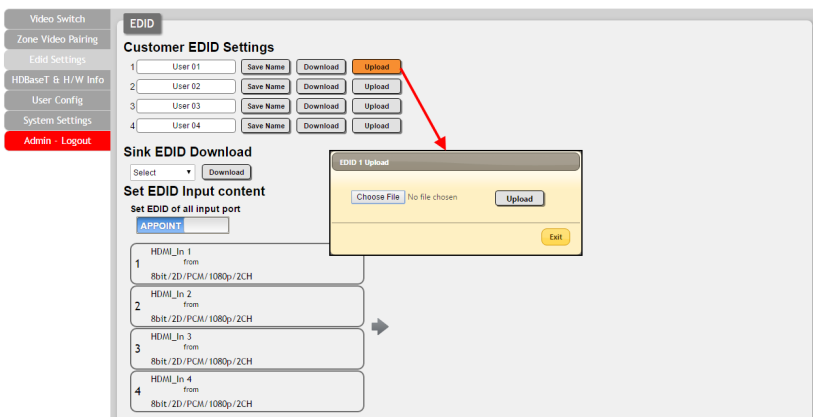

To upload a custom EDID, please click the “Upload” button next to the Customer EDID Settings item you would like to change. An EDID Upload window will appear, allowing you to locate and upload your preferred EDID file from the file directory on your local PC. Once the correct file has been selected, please click the “Upload” button in the window, and the file will be transferred to the matrix.

• Sink EDID Download

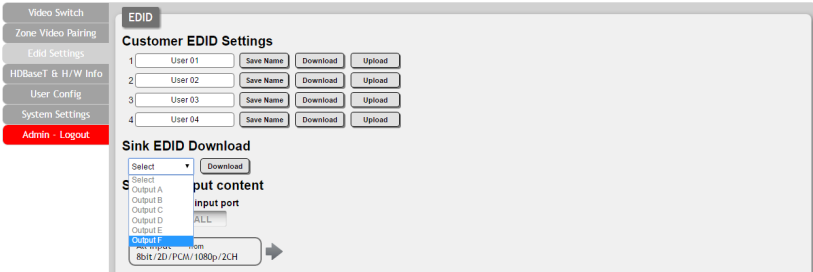

To save an existing custom EDID to your local PC please press the “Download” button next to the Customer EDID Settings item you would like to save. An EDID Download window will appear, allowing you to save the EDID file to your local PC. Once a file save location has been selected, please click the “Download” button in the window, and the file will be transferred to your PC.

• Set EDID Input Content

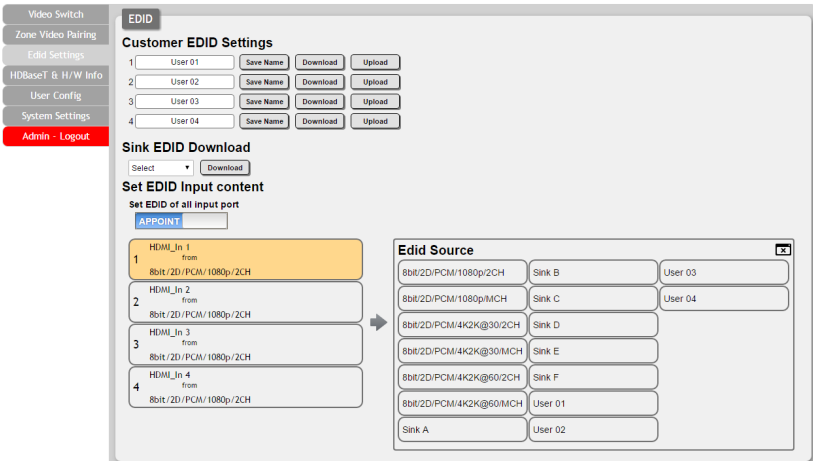

The Set EDID Input Content section allows for the assignment of an EDID to each individual input port, or to all inputs at once. Click the selection bar to toggle between individual assignment, or all inputs.

The unit comes with the following 6 default EDIDs:

- **FHD/2CH:** 1080p/60Hz(148M), 2.0 LPCM, 8-bit color.
- **FHD/MCH:** 1080p/60Hz(148M), 7.1 LPCM and bitstream, 8-bit color.
- **4K UHD/2CH:** 3840×2160p/30Hz (297M), 2.0 LPCM, deep color (8/10/12-bit).
- **4K UHD/MCH:** 3840×2160p/30Hz (297M), 7.1 LPCM and bitstream, Deep Color (8/10/12-bit).
- **4K UHD+/2CH :** 3840×2160p/60Hz (594M), 2.0 LPCM, deep color (8/10/12-bit).
- **4K UHD+/MCH:** 3840×2160p/60Hz (594M), 7.1 LPCM and bitstream, deep color (8/10/12-bit).

Note: In some rare cases it is possible for custom or external EDIDs to cause compatibility issues with certain sources. If this happens, it is recommended to switch to one of the 6 default EDIDs for maximum compatibility.

6.10.4 HDBaseT & H/W Info

Port	Local FwID	Remote FwID
A	V5010 Tx v3100.3	V5010 Rx v3100.3
B	V5010 Tx v3100.3	-
C	V5010 Tx v3100.3	-
D	V5010 Tx v3100.3	-

This page provides information concerning the temperature inside the matrix near critical components (areas 1 & 2) and the HDBaseT firmware versions used in the matrix and in connected receivers.

6.10.5 User Config

The WebGUI and Telnet username/password are set on this page. Two management levels are available: “Administrator” and “General User”. The administrator username (“admin”) cannot be changed. The “Administrator” user has access to change all settings. The “General User” is not permitted to access or change information on the EDID Settings or System Settings pages.

6.10.6 System Settings

This page provides system configuration options including turning the power on/off, changing the network settings, downloading/restoring saved system configurations, resetting the system to factory defaults and updating the firmware.

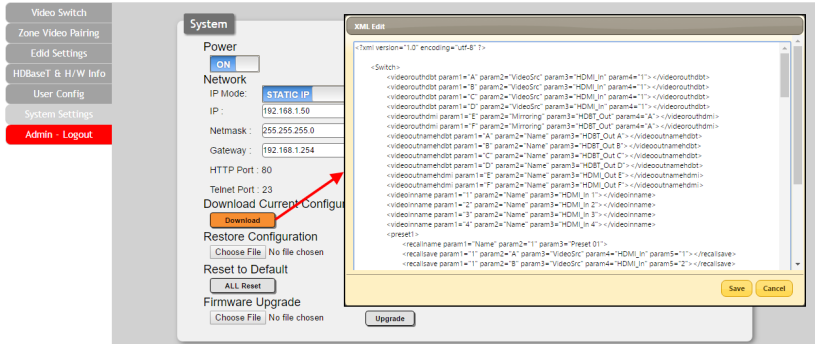

Click the “Download” button to save the current system configuration to your local PC. The current system configuration will be saved as XML file. The system configuration can also be restored from a saved XML file by clicking the “Choose File” button to locate the saved XML file, then clicking the “Restore” button.

6.10.7 Logout

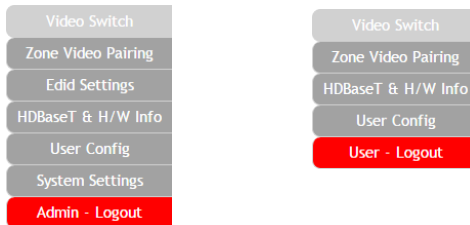

The “Logout” tab will indicate if the current user is connected as an Administrator or General User. Clicking the “Logout” tab will automatically log the user out of the WebGUI and return to login page.

7. CONNECTION DIAGRAM

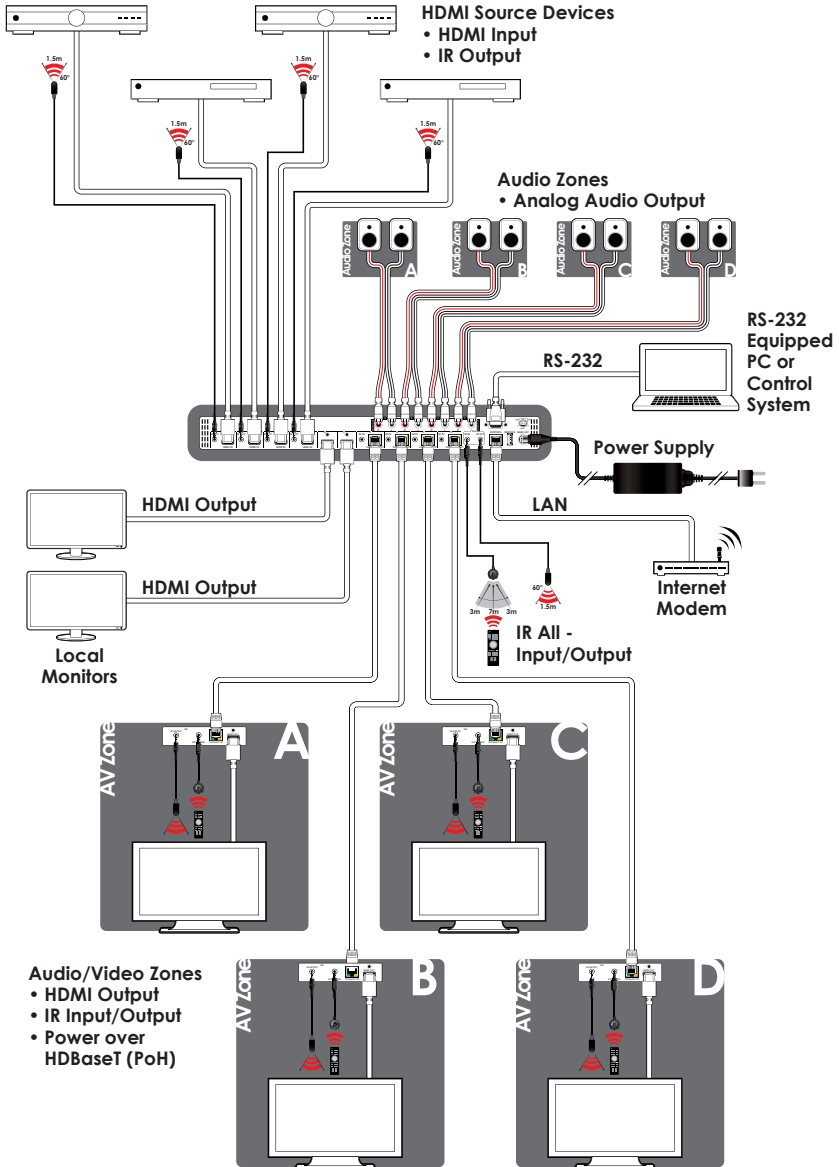

8. SPECIFICATIONS

8.1 Technical Specifications

Video Bandwidth	HDMI: 600 MHz/18 Gbps HDBaseT: 340 MHz/10.2 Gbps
Input Ports	4×HDMI
Output Ports	2×HDMI 4×Cat.5e/6/7 8×RCA [Stereo Audio]
Control Ports	5×IR Extender 5×IR Blaster 1×RS-232 (9-pin D-sub) 1×IP Control (RJ-45)
Service Port	1×USB 2.0
IR Frequency	38 kHz
Baud Rate	115200 bps
Power Supply	24 V/6.25 A DC (US/EU standards, CE/FCC/ UL certified)
ESD Protection	Human Body Model: ±8KV (Air Discharge) ±4KV (Contact Discharge)
Dimensions	438 mm×44 mm×270 mm (W×D×H) [Case Only] 482 mm×49 mm×279 mm (W×H×D) [All Inclusive]
Weight	3642 g
Chassis Material	Metal
Silkscreen Color	Black
Operating Temperature	0°C - 40°C/32°F - 104°F
Storage Temperature	-20°C - 60°C/-4°F - 140°F
Relative Humidity	20 - 90% RH (No-condensing)
Power Consumption	90 W

8.2 Supported Video Formats

8.2.1 Supported HDMI Resolutions

HDMI Resolution (Hz)	Input	Output
480i@60	✓	✓
480p@60	✓	✓
576i@60	✓	✓
576p@60	✓	✓
640×480@60	✓	✓
800×600@60	✓	✓
720p@50/60	✓	✓
1080i@50/60	✓	✓
1080p@24/50/60	✓	✓
1024×768@60	✓	✓
1280×1024@60	✓	✓
1360×768@60	✓	✓
1600×1200@60	✓	✓
1920×1200@60	✓	✓
2560×1440@60	✓	✓
3840×2160@24/25/30/50/59.94/60	✓	✓
4096×2160@24/50/59.94/60	✓	✓

8.2.2 Maximum HDMI Cable Length

HDMI Resolution	Input	Output
8-bit 1080p	10 meters	10 meters
12-bit 1080p	10 meters	10 meters
3840×2160@60Hz (YCbCr 4:2:0)	5 meters	5 meters
3840×2160@60Hz (YCbCr 4:4:4)	3 meters	3 meters

Note:

1. 6G (4K@60Hz YCbCr 4:4:4) HDMI signals will be converted to 3G (4K@60Hz YCbCr 4:2:0) signals when output over the eight HDBaseT ports. Some TVs may not support YCbCr 4:2:0 color or 4K@60Hz and may display the signal incorrectly, or not at all. Please check your TV's technical specs before attempting to display 4K@60Hz signals.
2. The use of "Premium High Speed HDMI" cables is highly recommended.

8.3 Supported Audio Formats

8.3.1 Linear PCM Audio

Channels (kHz)		
LPCM 2.0@44.1	LPCM 5.1@44.1	LPCM 7.1@44.1
LPCM 2.0@88.2	LPCM 5.1@88.2	LPCM 7.1@88.2
LPCM 2.0@176.4	LPCM 5.1@176.4	LPCM 7.1@176.4
LPCM 2.0@32	LPCM 5.1@32	LPCM 7.1@32
LPCM 2.0@48	LPCM 5.1@48	LPCM 7.1@48
LPCM 2.0@96	LPCM 5.1@96	LPCM 7.1@96
LPCM 2.0@192	LPCM 5.1@192	LPCM 7.1@192

8.3.2 Compressed Audio

Bitstreams
Standard Bitstream Formats
High-Bandwidth Bitstream Formats

Notes: The analog audio breakout function is supported in LPCM 2.0 formats only.



8.4 Category Cable Specifications

Cable Type	Cable Length	Supported Video Format
Cat.5e/6	60 meters	Most common Full HD video: <ul style="list-style-type: none">• Up to 1080p@60Hz, 36-bpp color• Data rates lower than 5.3Gbps or below 225MHz TMDS clock
	35 meters	Full HD & Ultra HD video: <ul style="list-style-type: none">• 1080p@60Hz, 48-bpp color• 4K@24/25/30Hz, 24-bpp color
Cat.6a/7	40 meters	<ul style="list-style-type: none">• Data rates higher than 5.3Gbps or above 225MHz TMDS clock

8.5 HDBaseT Features

HDBaseT Feature	Support
HD Video & Audio	✓
IR Control	✓
RS-232 Control	✓
Power to Compatible Receiver	✓
LAN	×

9. ACRONYMS

ACRONYM	COMPLETE TERM
Cat.5e	Category 5e Cable
Cat.6	Category 6 Cable
Cat.7	Category 7 Cable
CEC	Consumer Electronics Control
CLI	Command Line Interface
COAX	Coaxial
DVI	Digital Visual Interface
EDID	Extended Display Identification Data
GUI	Graphical User Interface
HDCP	High-bandwidth Digital Content Protection
HDMI	High-Definition Multimedia Interface
HDTV	High-Definition Television
IP	Internet Protocol
IR	Infrared
LAN	Local Area Network
OLED	Organic Light-Emitting Diode
PoH	Power over HDBaseT
USB	Universal Serial Bus
VGA	Video Graphics Array
WUXGA (RB)	Widescreen Ultra Extended Graphics Array (Reduced Blanking)



CYPRESS TECHNOLOGY CO., LTD.

www.cypress.com.tw