

EIKI

Owner's Manual Multimedia Projector

EK-830U/EK-831U

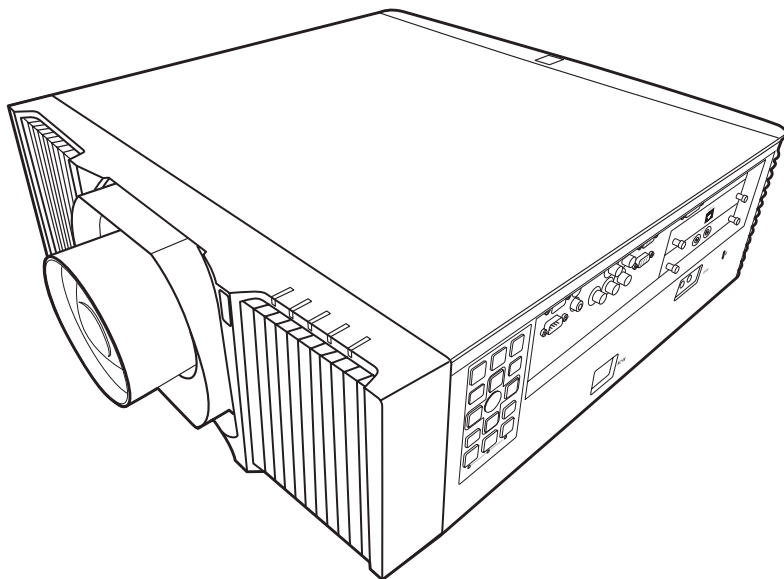

- Read this Owner's Manual carefully before using the projector, and keep it for future reference.
- The pictures for On Screen Display menus and the projector in this guide may slightly vary from the actual design.
- The contents of this Owner's Manual are subject to change without notice.

Contents

Usage Notice	4	LAN Control	58
<i>Safety Information</i>	4	<i>Wired LAN Terminal Functionalities</i>	58
<i>Safety Labels of This Machine</i>	6	<i>Supported External Devices</i>	58
<i>Regulation & Safety Notices</i>	14	<i>Controlling this Device with Web</i> <i>Browser</i>	59
<i>Other Information</i>	18	<i>Connecting to the Device</i>	59
Introduction	19	<i>Crestron</i>	59
<i>Product Features</i>	19	<i>Crestron Tools</i>	60
<i>Package Overview</i>	20	<i>Crestron Info</i>	60
<i>Product Overview</i>	21	Troubleshooting	61
<i>Connection Ports</i>	22	Appendices	67
<i>Control Panel</i>	23	<i>List of Compatible Signals</i>	67
<i>Remote Control</i>	25	<i>Configurations of Terminals</i>	67
<i>Remote Control Battery Installation</i>	28	<i>Terminal: Computer In (Mini D-sub 15 pin)</i> <i>[Monitor Out]</i>	73
<i>Remote Control Operating Range</i>	29	<i>Terminal: PC Control (D-sub 9 pin) (male)</i>	73
Basic Operations	30	<i>Terminal: 3D Sync</i>	74
<i>Installing the Projection Lens</i>	30	<i>Terminal: 12V Trigger Out</i>	74
<i>Removing the Projection Lens</i>	30	<i>Terminal: Wired Remote In/Out</i>	74
<i>Using the Projector in Portrait Mode</i>	31	<i>Specifications</i>	75
<i>Connecting the Projector</i>	32	<i>Cabinet Dimensions</i>	76
<i>Connecting to Computer/Notebook/AV</i> <i>Equipment/Other Devices</i>	32	<i>Trademarks</i>	77
<i>Connecting to HDBaseT Module</i>	33		
<i>Powering On/Off the Projector</i>	34		
<i>Powering On the Projector</i>	34		
<i>Powering Off the Projector</i>	35		
<i>Adjusting the Projected Image</i>	36		
<i>Adjusting the Position of Projector</i> <i>Image</i>	36		
<i>Adjusting the Projector Zoom and</i> <i>Focus</i>	36		
<i>Adjusting the Lens Position</i>	36		
<i>Adjusting Projection Image Size</i>	37		
User Settings	42		
<i>Using the On Screen Display (OSD)</i>	42		
<i>How to Operate</i>	42		
<i>Image Adjustment</i>	43		
<i>Display Settings</i>	46		
<i>Default Settings</i>	50		
<i>Options</i>	53		
<i>OSD Menu Tree</i>	55		

Usage Notice

Important Safety Information

Important:

It is strongly recommended that you read this section carefully before using the projector. These safety and usage instructions will ensure that you enjoy many years of safe use of the projector. Keep this manual for future reference.

Symbols Used

Warning symbols are used on the unit and in this manual to alert you of hazardous situations. The following styles are used in this manual to alert you to important information.

Note:

Provides additional information on the topic at hand.

Important:

Provides additional information that should not be overlooked.

Caution:

Alerts you to situations that may damage the unit.

Warning:

Alerts you to situations that may damage the unit, create a hazardous environment, or cause personal injury.

General Safety Information

- Do not open the unit case. Aside from the filter, there are no user-serviceable parts in the unit. For servicing, contact qualified service personnel.
- Follow all warnings and cautions in this manual and on the unit case.
- This projector has built-in laser module. Hazardous optical radiation possibly emits from this product. Do not stare into the beam which may be harmful to the eyes.
- Do not place the unit on an unstable surface, cart, or stand.
- Avoid using the system near water, in direct sunlight, or near a heating device.
- Do not place heavy objects such as books or bags on the unit.

Safety Instructions

- Please read this manual completely before installing and operating the projector.
- The projector provides many convenient features and functions. Proper operation may enable you to fully utilize the features and keep it in good condition. Otherwise, it will not only shorten the service life of the unit, but also may cause malfunction, a fire, or other accidents.
- If your projector cannot work properly, please read this manual again, check the operating methods and cable connection, and try the solutions in the part of Troubleshooting. If the problem still exists, contact the dealer or the service center.

Caution:



ELECTRIC SHOCK DO NOT OPEN



Caution:

To reduce the risk of electric shock, do not remove cover (or back), no user serviceable parts inside except lamp replacement. Refer servicing to qualified service personnel.



This symbol indicates that dangerous voltage constituting a risk of electric shock is present within this unit.



This symbol indicates that there are important operating and maintenance instructions in the user's manual with this unit.

FOR EU USERS

The symbol mark and recycling systems described below apply to EU countries and do not apply to countries in other areas of the world.

Your product is designed and manufactured with high quality materials and components which can be recycled and/or reused. The symbol mark means that electrical and electronic equipment, batteries and accumulators, at their end-of-life, should be disposed of separately from your household waste.

Note:

If a chemical symbol is printed beneath the symbol mark, this chemical symbol means that the battery or accumulator contains a heavy metal at a certain concentration. This will be indicated as follows:

Hg: mercury, Cd: cadmium, Pb: lead
In the European Union there are separate collection systems for used electrical and electronic equipment, batteries and accumulators.

Please, dispose of them correctly at your local community waste collection/recycling centre.

Please help us to conserve the environment we live in!



Safety Precautions

Caution:

- *The projector must be grounded.*
- *Do not expose the projector to raindrops or high humidity to avoid a fire or electric shock.*
- This projector produces intense light from the projection lens. Avoid staring directly into the lens, otherwise eye damage could be caused. Be especially careful that children do not stare directly into the beam.

Usage Notice

- Place the projector in a proper position. Otherwise it may result in fire hazard.
- Leave an appropriate space from the top, sides, and back of the shell in order to ventilate and cool down the projector. See Owner's manual for the minimum distance to be left each side. It must be satisfied if the projector is placed in sealed environment like a cabinet.

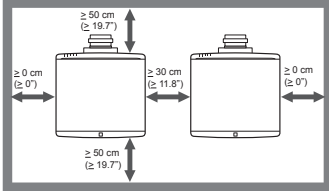

- Do not cover the vent of the projector. Poor radiation may shorten the service life or even cause dangers.
- Remove the AC power plug if the projector is not to be used for a long time.



Caution:

- *Do not set the projector in greasy, wet, or smoky conditions such as in a kitchen, to prevent a malfunction or accident. If the projector comes in contact with oil or chemicals, it may become deteriorated.*
- *Read and keep this manual for future reference.*
- *The mains plug/appliance coupler is used as disconnect device, the disconnect device shall remain readily operable.*

Safety Guide

- Read all of the instructions given here and retain them for later use. Unplug this projector from AC power supply before cleaning. Do not use liquid or aerosol cleaners.
- Use a damp cloth for cleaning.
- Follow all warnings and instructions marked on the projector.
- For added protection to the projector during a lightning storm, or when it is left unattended and unused for long periods of time, unplug it from the wall outlet. This will prevent damage due to lightning and power line surges.
- Do not expose this unit to rain or use near water... for example, in a wet basement, near a swimming pool, etc...
- Do not use attachments not recommended by the manufacturer as they may cause hazards.
- Do not place this projector on an unstable cart, stand, or table. The projector may fall, causing serious injury to a child or an adult, and serious damage to the projector.
- Use only with a cart or stand recommended by the manufacturer, or sold with the projector. Wall or shelf mounting should follow the manufacturer's instructions, and should use a mounting kit approved by the manufacturers.



- An appliance and cart combination should be moved with care. Quick stops, excessive force, and uneven surfaces may cause the appliance and cart combination to overturn.
- Slots and openings in the back and bottom of the cabinet are provided for ventilation, to ensure reliable operation of the equipment and to protect it from overheating.
- The openings should never be covered with cloth or other materials, and the bottom opening should not be blocked by placing the projector on a bed, sofa, rug, or other similar surface. This projector should never be placed near or over a radiator or heat register.
- This projector should not be placed in a build-in installation such as a book case unless proper ventilation is provided.
- Never push objects of any kind into this projector through cabinet slots as they may touch dangerous voltage points or short out parts that could result in a fire or electric shock. Never spill liquid of any kind on the projector.
- Do not install the projector near the ventilation duct of air-conditioning equipment.
- This projector should be operated only from the type of power source indicated on the marking label.
- If you are not sure of the type of power supplied, consult your authorized dealer or local power company.
- Do not overload wall outlets and extension cords as this can result in fire or electric shock. Do not allow anything to rest on the power cord. Do not locate this projector where the cord may be damaged by persons walking on it.
- Do not attempt to service this projector yourself as opening or removing Covers may expose you to dangerous voltage or other hazards. Refer all servicing to qualified service personnel.
 - Unplug this projector from wall outlet and refer servicing to qualified service personnel under the following conditions:
 - When the power cord or plug is damaged or frayed.
 - If liquid has been spilled into the projector.
 - If the projector has been exposed to rain or water.
 - If the projector does not operate normally by following the operating instructions. Adjust only those controls that are covered by the operating instructions as improper adjustment of other controls may result in damage and will often require extensive work by a qualified technician to restore the projector to normal operation.
 - If the projector has been dropped or the cabinet has been damaged.
- When the projector exhibits a distinct change in performance - this indicates a need for service.
- When replacement parts are required, be sure the service technician has used replacement parts specified by the manufacturer that have the same characteristics as the original part. Unauthorized substitutions may result in fire, electric shock, or injury to persons.

Usage Notice

- Upon completion of any service or repairs to this projector, ask the service technician to perform routine safety checks to determine that the projector is in safe operating condition.

Information for users in the European Union

This is a device to project images onto a screen, etc., and is not intended for use as indoor lighting in a domestic environment. Directive 2009/125/EC.

Warning:

Do not aim a laser pointer at the lens aperture, which may damage the DMD in the projector and cause personal injury.

We are not responsible for the hurt and damage caused by the improper use of laser pointer even in warranty period.

Air circulation

Vents in the cabinet are provided for ventilation. To ensure reliable operation of the product and to protect it from overheating, these openings must not be blocked or covered.



Caution:

- Hot air is exhausted from the exhaust vent. When using or installing the projector, the following precautions should be taken.
- Do not put any flammable objects, or spray can near the projector. Hot air is exhausted from the air vents.
- Keep the exhaust vent at least 1m away from any objects.
- Do not touch a peripheral part of the exhaust vent, especially screws and metallic part. This area will become hot while the projector is being used.
- Do not put anything on the projector. Objects put on the cabinet will not only get damaged but also may cause fire hazard by heat.
- Cooling fans are provided to cool down the projector.
- The fan's running speed is changed according to the temperature inside the projector.

Moving the projector

When moving the projector, take care of the lens and retract the adjustable foot to prevent damage to the lens and cabinet.



Caution in moving or transporting the projector

- Do not drop or bump the projector, otherwise damages or malfunctions may result.
- When carrying the projector, use a suitable carrying case.
- Do not transport the projector by courier or any other transport service in an unsuitable transport case. This may cause damage to the projector.

For information about transporting the projector by courier or any other transport service, consult your dealer.

- Do not put the projector in a case before it is cooled enough.



Caution in ceiling installation the projector

- Only qualified personal is authorized for ceiling installation.
- We are not responsible for the hurt and damage caused by ceiling bracket that purchased from unauthorized dealer even in warranty period.
- Remove the ceiling bracket immediately while not use.
- While installing, torque screwdriver is suggested, don't use electric or impact-type screwdriver.
- Please read the manual of bracket for details.
- Please read the Owner's Manual, and confirm screw size and location of screw holes on the projector
- The bracket is subject to change without notice.

Safety Labels of This machine

Laser Notice

<For USA and Canada>

This Product is classified as Class 3R of IEC60825-1:2007 and also complies with 21 CFR 1040.10 and 1040.11 except for deviations pursuant to Laser Notice No.50, dated June 24, 2007.



<For EU countries, Japan, and China>

IEC 60825-1:2014: CLASS 1 LASER PRODUCT - RISK GROUP 2

Wavelength:
449-461 nm
Pulse duration:
1.66 ms
Max. output:
98 mW

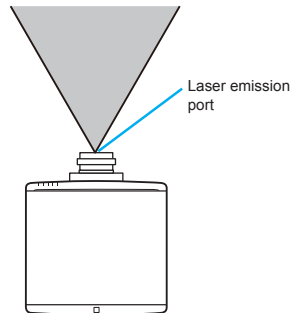

Usage Notice

1. Do not look into the lens while the light source is on. The strong light from the light source may cause damage to your eyesight. RG2 IEC 62471-5:2015
2. Do not place anything in front of the lens while the projector is operating. Things placed in front of the lens may overheat and burn or start a fire. If you want to temporarily stop the projected image, use the Blank key on the remote control.
3. Do not remove any screws. Do not block or cover the vents.
4. Do not look into the lens. (For USA and Canada only).
5. Laser aperture warning: (For USA and Canada only).
 - CLASS 3R LASER PRODUCT-AVOID DIRECT EYE EXPOSURE
 - Do not look into the light source using optical instruments (such as magnifying glasses and mirrors). Visual impairment could result.
 - When turning on the projector, make sure no one within projection range is looking at the lens.

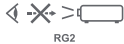

- Keep any items (magnifying glass etc.) out of the light path of the projector. The light path being projected from the lens is extensive, therefore any kind of abnormal objects that can redirect light coming out of the lens, can cause an unpredictable outcome such as a fire or injury to the eyes.
6. Laser aperture warning: (For other countries).
 - CLASS 1 LASER PRODUCT - RISK GROUP 2
 - Do not stare into the beam, maybe harmful to the eyes.
7. Risk group 3: (Except USA and Canada)

This projector may become RG3 when an interchangeable lens with throw ratio greater than the number stated on the label.

 - As with any bright light source, do not stare into the beam. RG2 IEC 62471-5:2015
 - No direct exposure to the beam shall be permitted. RG3 IEC 62471-5:2015
 - Operators shall control access to the beam within the hazard distance or install the product at the height that will prevent spectators' eyes from being in the hazard distance.

- Hazard distance

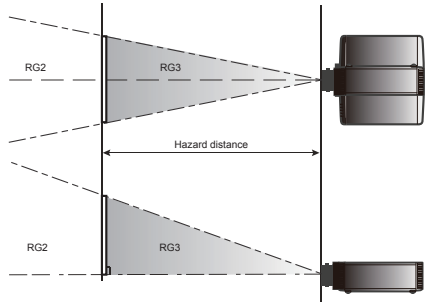

	Description	Throw Ratio	Hazard Distance	IEC62471-5:2015
AH-AC25020 Lens Type R0	Ultra Short Throw Lens	0.377	NA	RG2
AH-AC22060 Lens Type R1	Ultra Short Throw Zoom Lens	0.76-0.95	NA	RG2
AH-AC22070 Lens Type R2	Short Throw Zoom Lens	1.14-1.71	NA	RG2
AH-AC21020 Lens Type R3	Standard Zoom Lens	1.61-2.42	NA	RG2
AH-AC24020 Lens Type R4	Middle Throw Zoom Lens	2.37-3.60	NA	RG2
AH-AC23020 Lens Type R5	Long Throw Zoom Lens	3.53-5.65	1550 mm	RG3
AH-AC23030 Lens Type R6	Ultra Long Throw Zoom Lens	5.52-8.83	1370 mm	RG3

- Cinema projectors that have a hazard distance greater than 1 m and emit light into an uncontrolled area where persons may be present should be positioned in accordance with "the fixed projector installation" parameters, resulting in a hazard distance that does not extend into the audience area unless the beam is at least 2 m above the floor level.
- In non-cinema, environments where unrestrained behavior is reasonably foreseeable, the minimum separation height should be greater than or equal to 3.0 m to prevent potential exposure, for example by an individual sitting on another individual's shoulders, within the hazard distance. For example, a sufficiently large separation height may be achieved by mounting the projector on the ceiling or through the use of physical barriers.

Usage Notice

Safety Labels

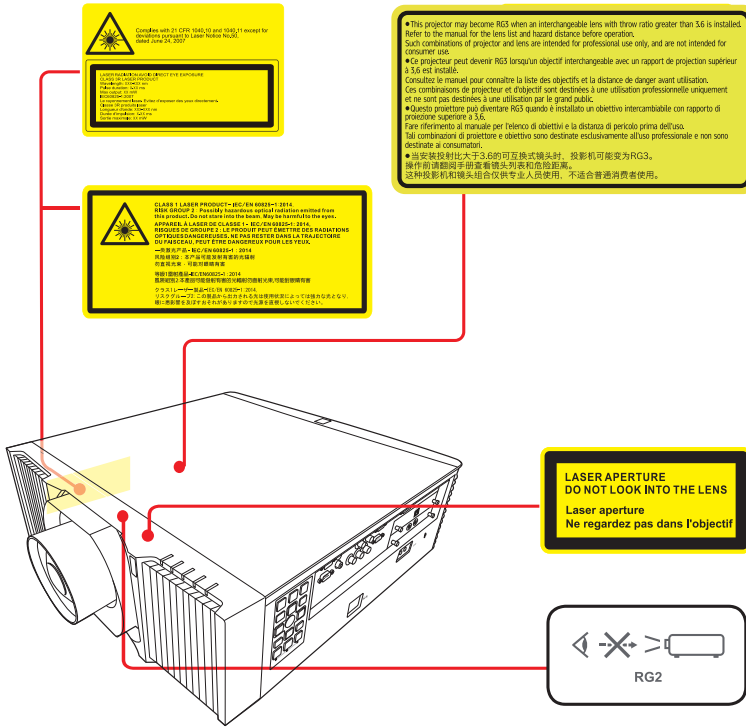

Usage Notice

Compliance

FCC Caution

Note: This equipment has been tested and found to comply with the limits for a Class* digital device, pursuant to Part 15 of the FCC Rules. These limits are designed to provide reasonable protection against harmful interference in a residential installation. This equipment generates, uses, and can radiate radio frequency energy, and if not installed and used in accordance with the instructions, may cause harmful interference to radio communications. However, there is no guarantee that interference will not occur in a particular installation. If this equipment does cause harmful interference to radio or television reception, which can be determined by turning the equipment off and on, the user is encouraged to try to correct the interference by one or more of the following measures:

- Reorient or relocate the receiving antenna.
- Increase the separation between the equipment and receiver.
- Connect the equipment into an outlet on a circuit different from that to which the receiver is connected.
- Consult the dealer or an experienced radio/TV technician for help

Use of shielded cable is required to comply with Class* limits in Subpart B of Part 15 of FCC Rules.

* See the rating label on the projector if class A or B.

Do not make any changes or modifications to the equipment unless otherwise specified in the instructions. If such changes or modifications should be made, you could be required to stop operation of the equipment.

Trade Name : EIKI

Responsible party : EIKI International, Inc.

Address : 30251 Esperanza Rancho Santa Margarita CA 92688-2132

Telephone No. : 800-242-3454 (949-457-0200)

Canadian Radio Interference Regulations:

This digital apparatus meets all requirements of the Canadian ICES-003.

** See the rating label on the projector if class A or B.*

AC Power Cord Requirement

The AC Power Cord supplied with this projector meets the requirement for use in the country you purchased it.

AC Power Cord for the United States and Canada:

AC Power Cord used in the United States and Canada is listed by the Under-writers Laboratories (UL) and certified by the Canadian Standard Association (CSA).

AC Power Cord has a grounding-type AC line plug.

This is a safety feature to be sure that the plug will fit into the power outlet. Do not try to defeat this safety feature. Should you be unable to insert the plug into the outlet, contact your electrician.

AC Power Cord for the United Kingdom:

This cord is already fitted with a moulded plug incorporating a fuse, the value of which is indicated on the pin face of the plug. Should the fuse need to be replaced, an ASTA approved BS 1362 fuse must be used of the same rating, marked thus . If the fuse cover is detachable, never use the plug with the cover omitted. If a replacement fuse cover is required, ensure it is of the same colour as that visible on the pin face of the plug (i.e. red or orange). Fuse covers are available from the Parts Department indicated in your User Instructions.

If the plug supplied is not suitable for your socket outlet, it should be cut off and destroyed. The end of the flexible cord should be suitably prepared and the correct plug fitted.

Warning:

A plug with bared flexible cord is hazardous if engaged in a live socket outlet.

The Wires in this mains lead are coloured in accordance with the following code:

- Green-and-yellow Earth
- Blue Neutral
- Brown Live

As the colours of the wires in the mains lead of this apparatus may not correspond with the coloured markings identifying the terminals in your plug proceed as follows:

- The wire which is coloured green-and-yellow must be connected to the terminal in the plug which is marked by the letter E or by the safety earth symbol or coloured green or green-and-yellow.
- The wire which is coloured blue must be connected to the terminal which is marked with the letter N or coloured black.
- The wire which is coloured brown must be connected to the terminal which is marked with the letter L or coloured red.

Warning:

This apparatus must be earthed.

The socket-outlet should be installed near the equipment and easily accessible.

ABOUT THE LASER LIGHT SOURCE

- Warning- Do not look into the lens or vent when the product is on. The bright light may damage your eyes. Be especially careful in an environment with children.
- Caution- This projector has built-in laser module. Hazardous optical radiation possibly emits from this product. Do not stare into the beam which may be harmful to the eyes.
- Caution- Use of controls or adjustments or performance of procedures other than those specified herein may result in hazardous radiation exposure.
- Caution- Do not block the projection light when it is on. If you do so, the part that is blocking the projection light may get quite hot and deform, deteriorate or cause a burn or fire. The reflected light may make the lens hot and cause a product failure. To temporarily suspend projection, select the Blank function. To suspend longer, turn off the product.
- Caution- Leave 30 cm or over space between the projectors when projectors are installed side by side.

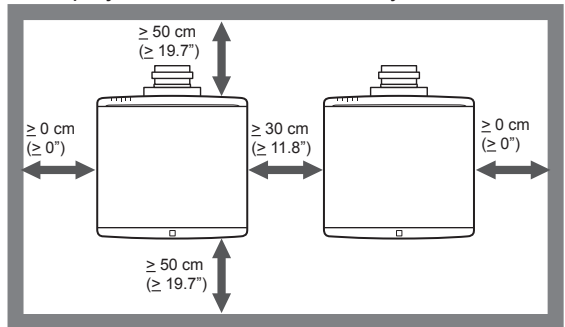

Usage Notice

- Caution- For 360° installation, install the projector more than 50 cm away from the wall or the floor. When the air intake and discharge outlet are obstructed, the temperature inside the projector will rise and this may result in a malfunction.

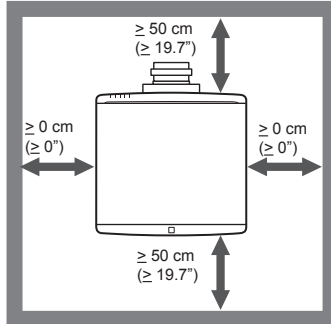

- Caution- When installing the projector on the right side, leave a space of at least 50 cm between the exhaust vent and the wall and a space of at least 50 cm for the intake vent.

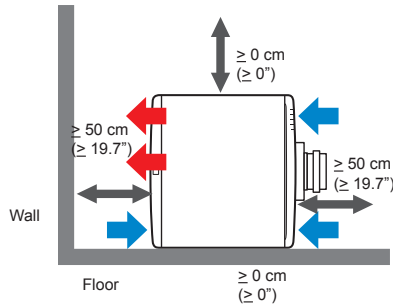

Usage Notice

- **Caution-** When installing the projector on the left side, leave a space of at least 50 cm between the exhaust vent and the wall and a space of at least 50 cm for the intake vent.

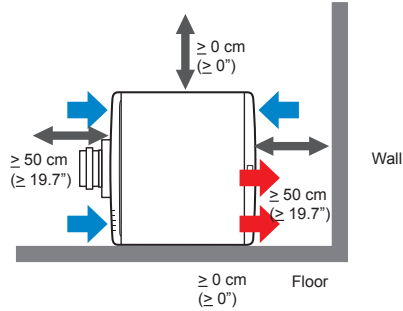

- **Caution-** Do not pile up more than 3 projectors.

REMOTE CONTROL BATTERY

Warning

- Never throw batteries into a fire.

Using the batteries improperly may cause them to explode or leak and may result in serious injury. If battery-leaking fluid contacts skin, wash the fluid off immediately with clean water and consult a doctor. If the fluid spills on an instrument, avoid contact and wipe it off using tissue paper. Then dispose of the used tissue paper as flammable garbage after moistening the tissue with water.

- Keep new and used batteries away from children.

If the battery compartment does not close securely, stop using the product and keep it away from children. If you think batteries might have been swallowed or placed inside any part of the body, seek immediate medical attention.

Notes

- Use the recommended battery type.
- Dispose of batteries in a designated disposal area.
- Attention should be drawn to the environmental aspects of battery disposal.
- If the remote control does not operate correctly, or if the operating range becomes reduced, replace the batteries.
- Avoid contact with water or liquid.
- Do not expose the remote control to moisture or heat.
- Do not drop the remote control.
- If the batteries have leaked in the remote control, carefully wipe the case clean and install new batteries.
- Dispose of used batteries according to the instructions.
- The remote control may fail to operate if the infrared remote sensor is exposed to bright sunlight or fluorescent lighting.

Important:

Contents of this manual are subject to change without prior notice. In no event will the company be liable for direct, indirect, special, incidental, or consequential damages as a result of handing or operating this product.

Regulation & Safety Notices

This appendix lists the general notices of your Projector.

Notice: Users in the United States of America FCC notice

MODEL NAME: EK-830 series

TRADE NAME: EIKI MODEL NAME: EK-830 series Tested To Comply With FCC Standards FOR COMMERCIAL OR OFFICE USE
--

This device complies with Part 15 of the FCC Rules. Operation is subject to the following two conditions:

1. This device may not cause harmful interference and
2. This device must accept any interference received, including interference that may cause undesired operation.

This equipment has been tested and found to comply with the limits for a Class A digital device, pursuant to Part 15 of the FCC Rules. These limits are designed to provide reasonable protection against harmful interference when the equipment is operated in a commercial environment. This equipment generates, uses, and can radiate radio frequency energy and, if not installed and used in accordance with the instruction manual, may cause harmful interference to radio communications. Operation of this equipment in a residential area is likely to cause harmful interference in which case the user will be required to correct the interference at his own expense.

Caution: Changes or modifications not expressly approved by the party responsible for compliance could void the user's authority to operate the equipment.

RESPONSIBLE PARTY: EIKI International, Inc. 30251 Esperanza Rancho Santa Margarita CA 92688-2132 Phone: 800-242-3454 (949-457-0200)

Usage Notice

Notice: Shielded cables

All connections to other computing devices must be made using shielded cables to maintain compliance with FCC regulations.

Caution

Changes or modifications not expressly approved by the manufacturer could void the user's authority, which is granted by the Federal Communications Commission, to operate this projector.

Notes to Users in the State of California

Perchlorate Material - special handling may apply. See www.dtsc.ca.gov/hazardouswaste/perchlorate.

Declaration of Conformity for EU countries

- EMC Directive 2014/30/EU (including amendments)
- Low Voltage Directive 2014/35/EU

Warning

This equipment is compliant with Class A of CISPR 32. In a residential environment this equipment may cause radio interference.

Notice: Users in EU countries CE Marking Traceability Information (For EU Countries Only)

User Information on Electrical and Electronic Equipment

Users in the countries where this symbol shown in this section has been specified in national law on collection and treatment of E-waste.

Our Products contain high quality components and are designed to facilitate recycling. Our products or product packaging are marked with the symbol below.



This product contains substances which are harmful to humans and the environment.

The symbol indicates that the product must not be treated as municipal waste. It must be disposed of separately via the appropriate return and collection systems available. By following these instructions you ensure that this product is treated correctly and help to reduce potential impacts on the environment and human health, which could otherwise result from inappropriate handling.

Recycling of products helps to conserve natural resources and protect the environment.

For more detailed information on collection and recycling systems for this product, please contact the shop where you purchased it, your local dealer or sales/service representatives.

Notice: Users in Turkey

AEEE Yönetmeliğine Uygundur.

Bu sistem sarf malzemeleri ve yedek parçaları da dahil olmak üzere AEEE Yönetmeliğine Uygundur.

Notice: Users in the EU Note for the Battery and/or Accumulator Symbol



In accordance with the Battery Directive 2006/66/EC Article 20 Information for end-users Annex II, the above symbol is printed on batteries and accumulators. This symbol means that in the European Union, used batteries and accumulators should be disposed of separately from your household waste. In the EU, there are separate collection systems for not only used electrical and electronic products but also batteries and accumulators. Please dispose of them correctly at your local community waste collection/recycling centre.

Other Information

Copyrights to Images

When projecting images using the projector, be careful not to infringe the copyright of protected materials.

The following are examples that may infringe the copyright of protected materials.

- Broadcasting images or movies for commercial purposes
- Modifying images or movies using functions such as freeze, magnify, or zoom to broadcast images for commercial purposes or public viewing
- Varying the aspect ratio of images or movies using a function that changes the screen size to broadcast images for commercial purposes or public viewing

Note to Users Viewing 3D Images

Pay attention to the following points when viewing images using 3D glasses with projector:

- How 3D images are viewed may vary according to the individual.
- Do not use 3D glasses for viewing any material other than 3D images.
- Before viewing 3D images, make sure to read the manuals provided with your 3D glasses and 3D compatible content.
- Avoid viewing 3D images for a long period of time. Take a break of 15 minutes or longer after every hour of viewing.
- If you feel sick while viewing 3D images, stop viewing them. If you continue to feel sick, consult a doctor.
- When viewing 3D image in a room where LED lighting system or fluorescent lights are used, you may feel that the light in the room flickers. If this is the case, dim the lights until you do not notice any flickers, or turn off the lights.
- If you or any member of your family has a history of lightsensitive seizures, consult a doctor before viewing 3D images.

Product Features

Outstanding features include:

- Native 1920 x 1200 WUXGA resolution with Auto/4:3/16:9/16:10/1.88:1/2.35:1 aspect ratio supported
- 3D function with Blu-Ray 3D supported for projecting 3D content using DLP Link Technology
- High brightness and contrast ratio
- Various picture modes
- NTSC/PAL/SECAM and HDTV (720p, 1080i, 1080p) compatibility
- Economy (ECO) mode for extending light source life
- Advanced keystone correction for delivering optimum presentations
- User friendly multilingual On Screen Display
- Extensive lens options with motorized focus/zoom and motorized lens shift functions
- LAN function for remote management on the projectors from a web browser
- Compatibility with PJ-Link, Crestron, AMX, and Extron
- Compatibility with 3D VESA standards

Package Overview

This projector comes with all the items shown below. Check to make sure your unit is complete. Contact your dealer immediately if anything is missing.

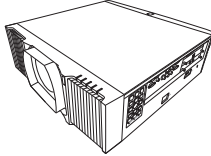

(Projection Lens is optional)

Projector

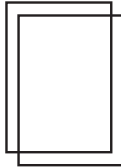

Quick Start Guide

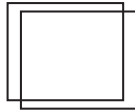

Safety Information



Remote Control (with Batteries)

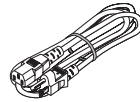

Power Cord (EU and US type)

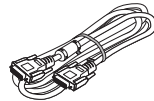

VGA cable

Product Overview

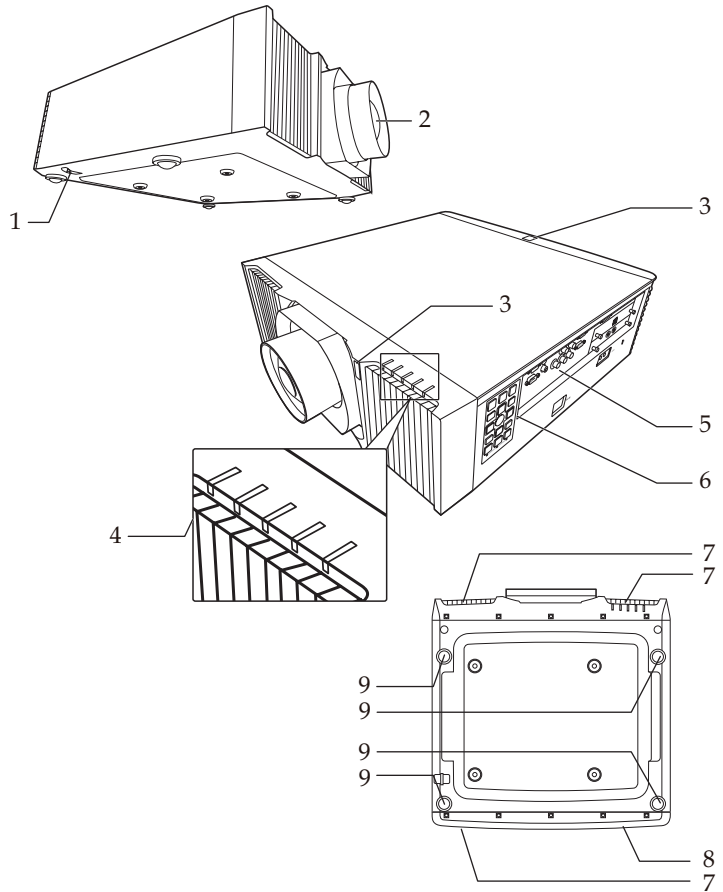

-
1. Security bar
 2. Projection lens (optional)
 3. IR sensor
 4. LED Indicator
 5. Connection ports
 6. Control panel
 7. Intake vent
 8. Exhaust vent
 9. Adjustable foot
-

Connection Ports

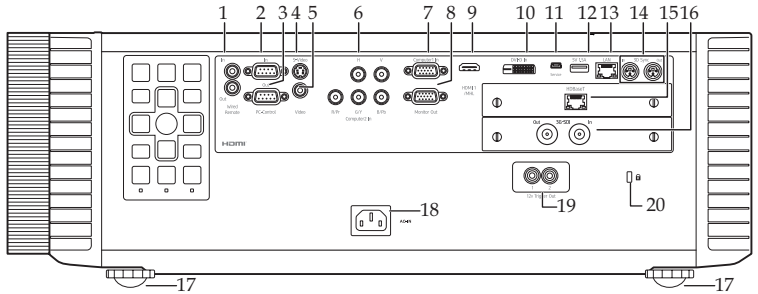

Note

- The interface is subject to model's specifications.
- Compatible with MHL version 2, the charging power 5V@0.9A.
- To use this feature, you must plug in the power adapter/cable/cord before turn on/off the projector.
- Do not use this jack for anything other than intended use.

1. Wired remote control In terminal
2. Wired remote control Out terminal
3. PC-Control (In) terminal
4. PC-Control (Out) terminal
5. S-Video In terminal
6. Video In terminal
7. Computer2 In terminal
8. Computer1 In terminal
9. Monitor Out terminal
10. HDMI 1/MHL terminal
11. DVI-D In terminal
12. Service terminal
13. USB-A terminal (5V 1.5A Out)
14. LAN terminal
15. 3D sync terminal (In/Out)
16. HDBaseT terminal / Optional slot *
17. 3G-SDI terminal (In/Out) / Optional slot *
17. Adjustable feet
18. AC In socket
19. 12V Trigger Out terminals
20. Anti-theft lock hole (Kensington™ lock)



Warning:

As a safety precaution, disconnect all power to the projector and connecting devices before making connections.

Control Panel

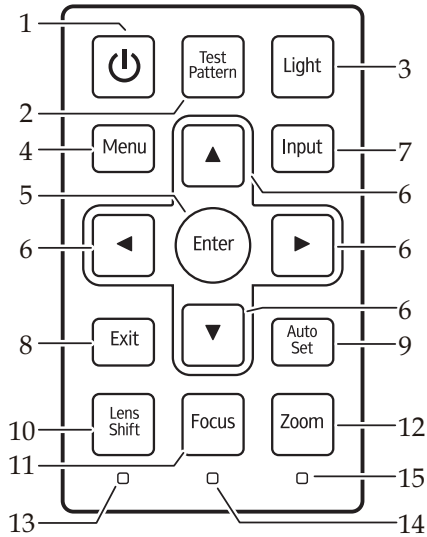

1	Power	Toggles the projector between standby mode and on.
2	Test Pattern	Display the test pattern.
3	Light	Turn on or off the backlight of the control panel.
4	Menu	Press “Menu” to launch the on screen display (OSD), or close the OSD menu.
5	Enter	Select or confirm settings.
6	Four Directional Select Keys	Use ▲, ▼, ◀, or ▶ to select items or make adjustments to your selection.
7	Input	Press “Input” to choose your desired input source.
8	Exit	Cancel the selection, or go back to a previous page.
9	Auto Set	Automatically synchronize the projector to the input source.
10	Lens Shift	Press “Lens Shift” and the indicator below lights up. Use ▲, ▼, ◀, or ▶ to shift the projection lens.

Introduction

11	Focus	Press “Focus” and the indicator below lights up. Use ▲, ▼, ◀, or ▶ to adjust the focus setting.
12	Zoom	Press “Zoom” and the indicator below lights up. Use ▲, ▼, ◀, or ▶ to adjust the zoom setting.
13	Indicator light for “Lens Shift”	The indicator lights up when “Lens Shift” is pressed.
14	Indicator light for “Focus”	The indicator lights up when “Focus” is pressed.
15	Indicator light for “Zoom”	The indicator lights up when “Zoom” is pressed.

Remote Control

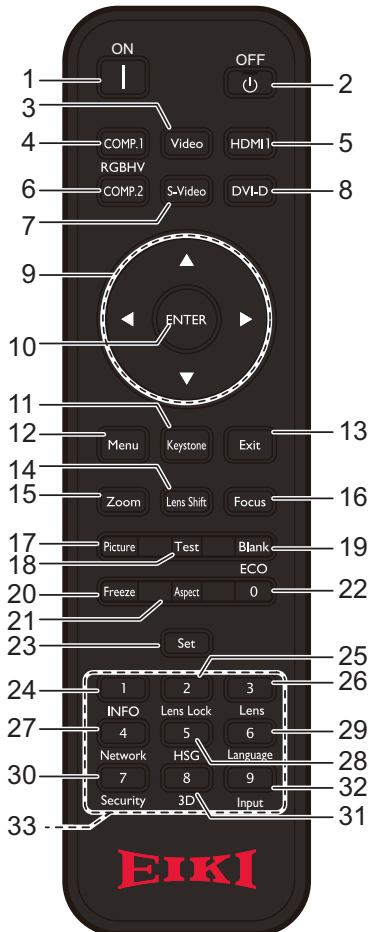

1		Turn the projector on.
2		Turn the projector off
3	Video	Press "Video" to choose between Video In and S-Video In terminal.
4	COMP.1	Press "Comp.1" to choose Computer1 In terminal.
5	HDMI 1	Press "HDMI 1" to choose between HDMI1/MHL In and HDMI2 In terminal.

Introduction

6	COMP.2	Press "Comp.2" to choose Computer2 In terminal.
7	S-Video	Press "S-Video" to choose S-Video terminal.
8	DVI-D	Press "DVI-D" to choose DVI-D In terminal.
9	Four Directional Select Keys	Use ▲, ▼, ◀, or ▶ to select items or make adjustments to your selection.
10	Enter	Confirm your section of items in sub menu operation.
11	Keystone	Display the Keystone correction menu.
12	Menu	Press "Menu" to launch the on screen display (OSD), or close the OSD menu.
13	Exit	Cancel the selection, or go back to previous page.
14	Lens Shift	Press "Lens Shift" and use ▲, ▼, ◀, or ▶ to shift the projection lens.
15	Zoom	Press "Zoom" and use ▲, ▼, ◀, or ▶ to adjust the zoom setting.
16	Focus	Press "Focus" and use ▲, ▼, ◀, or ▶ to adjust the focus setting.
17	Picture	Select the preset picture mode.
18	Test	Display the test pattern.
19	Blank	Hide the screen image.
20	Freeze	Pause the screen image. Press again to resume the screen image.
21	Aspect	Use this function to choose your desired aspect ratio.
22	Eco / 0	Dim the projector light source which will lower power consumption and extend the light source life. / Input numbers.
23	Set	Set the code for this remote control. Press and hold "Set", and then press a number (01, 02, 03...99) to designate an ID. You can control projector with the matching ID set in the "Options" > "Control" > "Projector ID" OSD. Press and hold "Set" and press "0" twice to cancel the remote control code.
24	INFO	Display the current projector related information.
25	Lens Lock	Display the Lens Lock menu.

Introduction

26	Lens	Display the Lens menu.
27	Network	Display the Network menu.
28	HSG	Display the HSG menu.
29	Language	Display the OSD language selection menu.
30	Security	Display the Security menu.
31	3D	Display the 3D menu.
32	Source	Display the Input Source menu.
33	Number (1~9)	Input numbers.

Remote Control Battery Installation

- 1 Press and slide open the battery cover as illustrated.
- 2 Install new batteries (AAA). Ensure that you have the batteries' polarity (+/-) aligned correctly.
- 3 Close the battery cover and press it down until it clicks into place. Do not mix different types of batteries or new and old batteries.

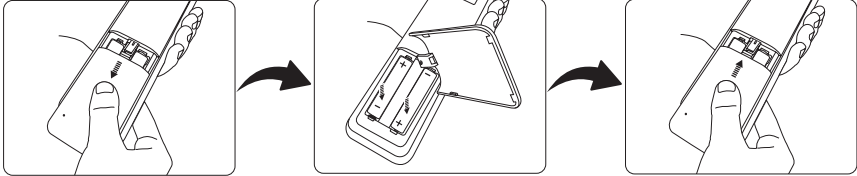

To ensure safe operation, please observe the following precautions :

- Use AAA type batteries.
- Avoid contact with water or liquid.
- Do not expose the remote control to moisture or heat.
- Do not drop the remote control.
- If the battery has leaked in the remote control, carefully wipe the case clean and install new batteries.
- Risk of an explosion if batteries are replaced by an incorrect type.
- Dispose of used batteries according to local ordinance regulations.
- Remove batteries from remote control when not using for extended periods.
- The remote control may fail to operate if the infrared remote sensor is exposed to bright sunlight or fluorescent lighting.

Remote Control Operating Range

Point the remote control toward the projector (Remote Receiver) when pressing any button.

Maximum operating range for the remote control is about 23.0' (7m) and $\pm 30^\circ$ (horizontally), $\pm 20^\circ$ (vertically) in front and top of the projector.

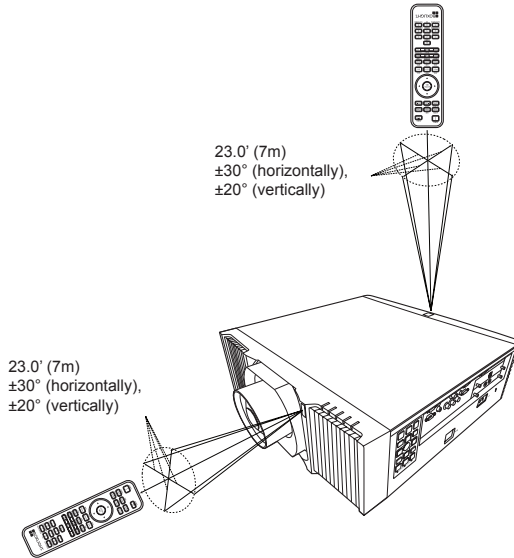

Installing the Projection Lens

Note

- Use Optional Lens AH-AC22060/AH-AC22070/AH-AC21020/AH-AC24020/AH-AC23020/AH-AC23030.
1. Remove the front lens cap and rear lens cap from the optional lens.
 2. Remove the dust cap and upper lens cover from the projector.
 3. Insert the projection lens. ❶
 4. Turn the lever counterclockwise until you feel it click into place to lock the lens in position. ❷
 5. Install the upper lens cover back by push down left and right side. ❸

Note

- For installing Optional Lens AH-AC25020, refer to the user manual that packed with the lens.

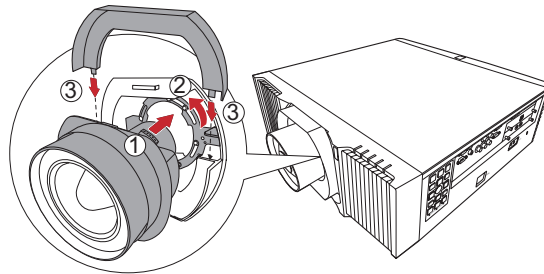

Removing the Projection Lens

1. Remove the upper lens cover by pull up the left and right side. ❶
2. Turn the lever clockwise to release the lens. ❷
3. Pull out the projection lens. ❸
4. Replace the upper lens cover and the dust cap.

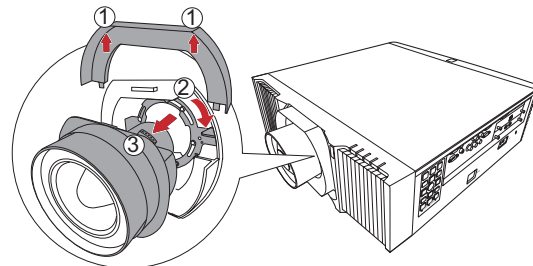

Using the Projector in Portrait Mode

The projector automatically enters the portrait mode of fan setting by detecting the installation angle.

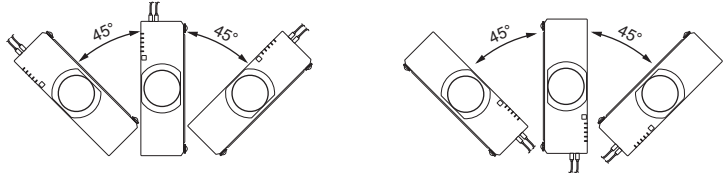

Do not use this function when AH-AC25020 lens is installed.

Note

- Make sure that the power plug is fully inserted into both the projector AC inlet and the wall outlet.
- The AC outlet must be near this equipment and must be easily accessible.
- Due to the difference in applications for each country, some regions may have different accessories.
- To ensure the projector works well with your computer, please make sure the timing of the display mode is compatible with your projector.
- Use the cables that come with the projector. (*)

Connecting the Projector

Connecting to Computer/Notebook/AV Equipment/Other Devices

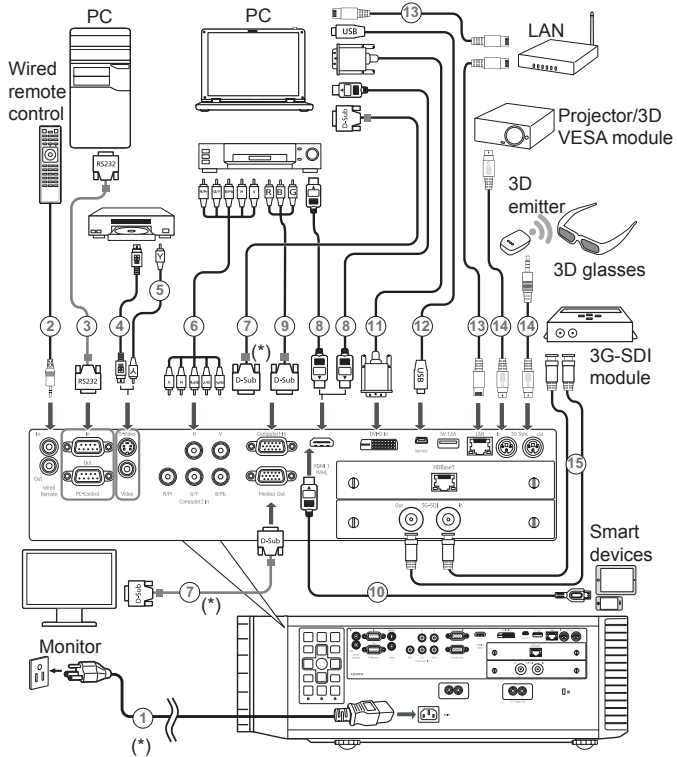

Note

- When "Monitor Out (Standby)" is set to "Off", the monitor out will be deactivated in standby mode.

1. Power cord (supplied)	9. RGB to VGA connector
2. Wired remote cable	10. HDMI (MHL) cable
3. RS232 cable	11. DVI cable
4. S-Video cable	12. USB cable
5. Video cable	13. LAN cable
6. 5-BNC cable	14. 3D emitter cable
7. VGA cable (supplied)	15. 3G-SDI cable
8. HDMI cable	

Connecting to HDBaseT Module

HDBaseT is a connectivity standard for whole-house and commercial distribution of uncompressed HD multimedia content. After installing the HDBaseT module to the projector and using the HDBaseT switching matrix (commercially available), you may connect multiple sources to your projector with HDBaseT connection.

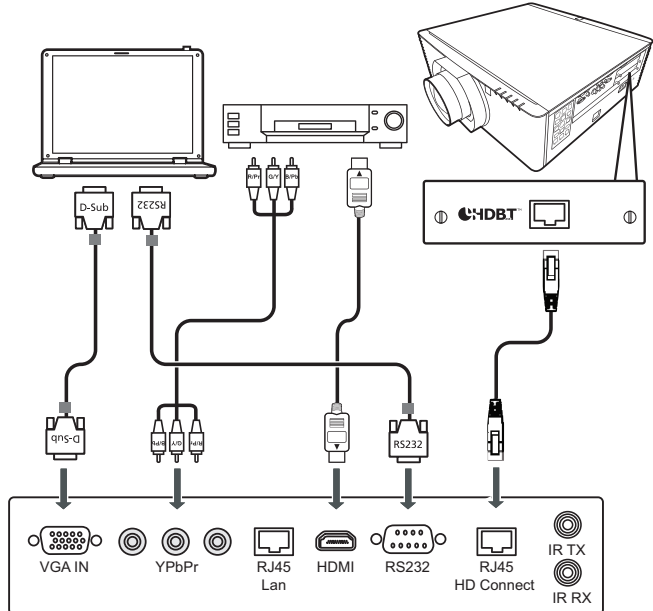

Note

- The illustration is for reference only, actual layout may vary.

- ❖ Use a shielded LAN cable up to 100 meters in length rated at CAT5e or better.
- ❖ The maximum transmission distance is 100 m. However, it may be shorter under some circumstances.
- ❖ Avoid using the LAN cable when it is coiled or bundled.
- ❖ Inserting or removing the LAN cable during projection may cause noise.
- ❖ Connectivity with all HDBaseT transmitters on the market is not guaranteed.
- ❖ Some HDBaseT transmitters may not enable correct projection when used to connect source equipment to the projector.
- ❖ Commands cannot be received through HDBaseT when the projector is in standby mode.

Note



- If you connect multiple sources at the same time, press "Input" on the control panel or the desired source button on the remote control to switch inputs.

Note

- Turn on the projector first and then the signal sources.

Powering On/Off the Projector

Powering On the Projector

1. Ensure that the power cord and signal cable are securely connected. The Power indicator will turn red.
2. Remove the lens cap.
3. Turn on the light source by pressing the  button on the control panel or  on the remote control. The Power indicator will flash blue.

A warning message regarding lens information will appear. Press any key to continue.

The startup screen will be displayed and the Power indicator will turn blue.

4. Turn on your source (computer, notebook, video player, etc.) The projector will detect your source automatically. Make sure that the "Auto Source" has been set to "On".



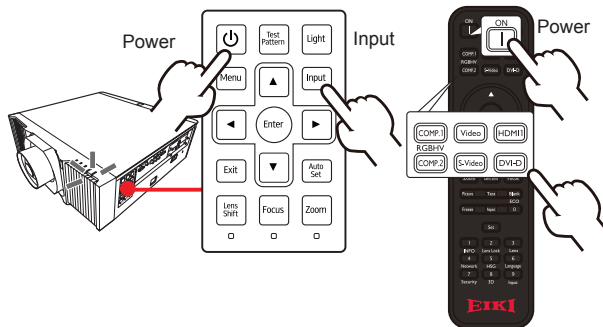

CAUTION:

- Do not look into the lens while the light source is on. The strong light from the light source may cause damage to your eyesight.
- Do not block the air intake or exhaust. Doing so could cause a fire due to internal overheating.
- Do not place your hands, face, or other objects near the air exhaust, the light source cover or the bottom of the unit. Doing so could result in injury and/or damage the object.



Powering Off the Projector

1. Press the  button and you will see a message on the screen.
2. Press the  button again to turn off the projector light source.
3. Disconnect the power cord from the electrical outlet and the projector.



Caution:

Do not unplug the power cord until all of fans are stop-indicating the projector has cooled down.

Adjusting the Projected Image

Adjusting the Position of Projector Image

The projector is equipped with adjustable feet to raise and lower the image to fill the screen.

1. Locate the adjustable foot you wish to modify on the underside of the projector.
2. Rotate the adjustable ring clockwise to raise the projector or counter clockwise to lower it. Repeat with the remaining feet as necessary.

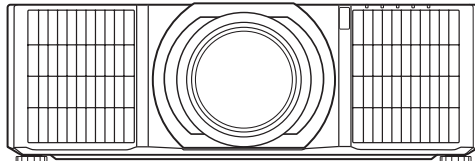

Front Adjustable feet
Maximum Length: 26.5mm



Note

- You can incline the projector up to 4.4° by rotating the adjustable feet.

Adjusting the Projector Zoom and Focus

Press “Zoom” or “Focus” on the control panel or remote control and use ▲, ▼, ◀, or ▶ to adjust the zoom or focus setting.

Adjusting the Lens Position

- ▶ To shift the lens:
 - Press “Lens Shift” on the control panel or remote control and use ▲, ▼, ◀, or ▶ to shift the projection lens upward, downward, to the left or to the right.

Basic Operations

Adjusting Projection Image Size

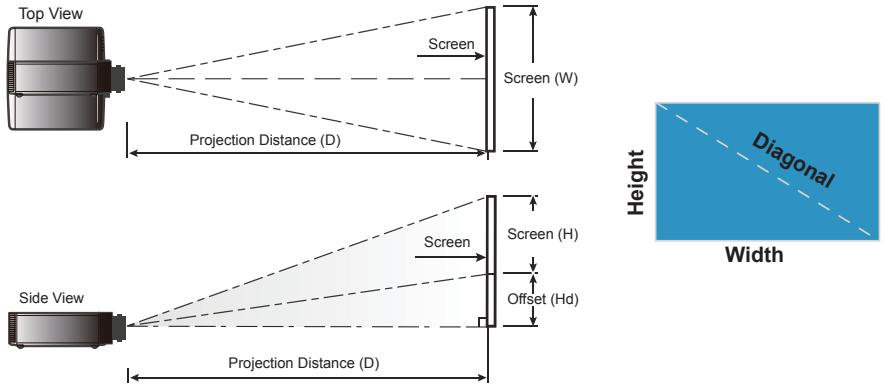

*Only with AH-AC21020/AH-AC24020/AH-AC23020/AH-AC23030 lens

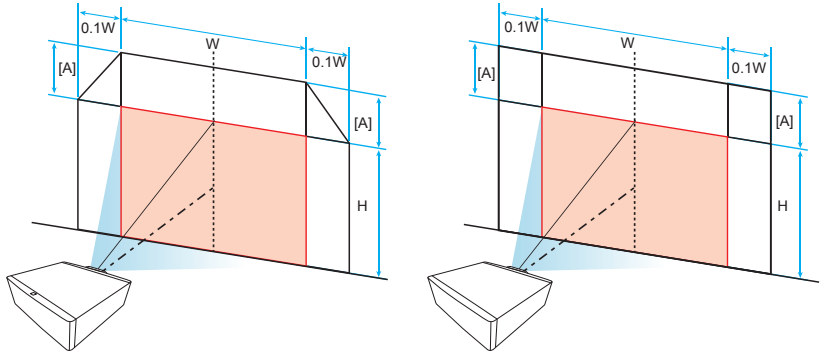

[A] differs when different lens is installed.

Lens	[A]
AH-AC21020	0.6H
AH-AC22060	0.5H
AH-AC22070	0.6H
AH-AC24020	0.6H
AH-AC23020	0.6H
AH-AC23030	0.6H
AH-AC25020	N/A

Basic Operations

Optional Lenses and projection size

Lens#		AH-AC21020	AH-AC22060	AH-AC22070	AH-AC24020	AH-AC23020	AH-AC23030	AH-AC25020
Throw Distance @100'	Wide	3.47m	1.63m	2.45m	5.10m	7.60m	11.89m	0.82m
	Tele	5.20m	2.04m	3.67m	7.76m	12.15m	19.02m	
Throw Ratio	Wide	1.61	0.76	1.14	2.37	3.53	5.52	0.38
	Tele	2.42	0.95	1.71	3.60	5.65	8.83	
Zoom Ratio		1.50	1.25	1.50	1.52	1.60	1.60	Fix
Zoom & Focus adjustment		Motorized						Fixed
F / #	Wide	1.60	1.84	1.82	1.80	1.80	1.84	2.00
	Tile	2.00	2.32	2.32	2.32	2.20	2.34	
f / mm	Wide	24.1	11.3	17.2	35.2	51.3	1.84	5.64
	Tile	35.8	14.1	25.5	53.5	82.5	126.00	
Offset / %	Left/Right	0 - ±10% TOL 2.34%						Fixed TOL 2.34%
	Up	0 - 60% TOL 3.75%	0 - 50% TOL 3.75%	0 - 60% TOL 3.75%	0 - 60% TOL 3.75%	0 - 60% TOL 3.75%	0 - 60% TOL 3.75%	83.2% TOL 3.75%
Projection Image size		60" - 300"						70" - 300"

Optional Lens: AH-AC21020 / R3

Diagonal length (inch) size of 16:10 Screen	Screen Size W x H				Projection Distance (D)				Offset (Hd)			
	(m)		(inch)		(m)		(feet)		(m)		(feet)	
	Width	Height	Width	Height	Wide	Tele	Wide	Tele	Min.	Max.	Min.	Max.
60	1.29	0.81	50.88	31.80	2.08	3.12	6.83	10.24	-0.40	0.08	-1.32	0.26
70	1.51	0.94	59.36	37.10	2.43	3.64	7.97	11.95	-0.47	0.09	-1.55	0.31
80	1.72	1.08	67.84	42.40	2.78	4.16	9.11	13.66	-0.54	0.11	-1.77	0.35
90	1.94	1.21	76.32	47.70	3.12	4.68	10.24	15.37	-0.61	0.12	-1.99	0.40
100	2.15	1.35	84.80	53.00	3.47	5.20	11.38	17.07	-0.67	0.13	-2.21	0.44
120	2.58	1.62	101.76	63.60	4.16	6.24	13.66	20.49	-0.81	0.16	-2.65	0.53
150	3.23	2.02	127.20	79.50	5.20	7.81	17.07	25.61	-1.01	0.20	-3.31	0.66
180	3.88	2.42	152.64	95.40	6.24	9.37	20.49	30.73	-1.21	0.24	-3.97	0.79
200	4.31	2.69	169.60	106.00	6.94	10.41	22.77	34.15	-1.35	0.27	-4.42	0.88
250	5.38	3.37	212.00	132.50	8.67	13.01	28.46	42.68	-1.68	0.34	-5.52	1.10
300	6.46	4.04	254.40	159.00	10.41	15.61	34.15	51.22	-2.02	0.40	-6.62	1.32

Basic Operations

Optional Lens: AH-AC22060 / R1

Diagonal length (inch) size of 16:10 Screen	Screen Size W x H				Projection Distance (D)				Offset (Hd)			
	(m)		(inch)		(m)		(feet)		(m)		(feet)	
	Width	Height	Width	Height	Wide	Tele	Wide	Tele	Min.	Max.	Min.	Max.
60	1.29	0.81	50.88	31.80	0.98	1.22	3.21	4.02	-0.40	0.00	-1.32	0.00
70	1.51	0.94	59.36	37.10	1.14	1.43	3.75	4.69	-0.47	0.00	-1.55	0.00
80	1.72	1.08	67.84	42.40	1.31	1.63	4.29	5.36	-0.54	0.00	-1.77	0.00
90	1.94	1.21	76.32	47.70	1.47	1.84	4.82	6.03	-0.61	0.00	-1.99	0.00
100	2.15	1.35	84.80	53.00	1.63	2.04	5.36	6.70	-0.67	0.00	-2.21	0.00
120	2.58	1.62	101.76	63.60	1.96	2.45	6.43	8.03	-0.81	0.00	-2.65	0.00
150	3.23	2.02	127.20	79.50	2.45	3.06	8.03	10.04	-1.01	0.00	-3.31	0.00
180	3.88	2.42	152.64	95.40	2.94	3.67	9.64	12.05	-1.21	0.00	-3.97	0.00
200	4.31	2.69	169.60	106.00	3.27	4.08	10.71	13.39	-1.35	0.00	-4.42	0.00
250	5.38	3.37	212.00	132.50	4.08	5.10	13.39	16.74	-1.68	0.00	-5.52	0.00
300	6.46	4.04	254.40	159.00	4.90	6.12	16.07	20.09	-2.02	0.00	-6.62	0.00

Optional Lens: AH-AC22070 / R2

Diagonal length (inch) size of 16:10 Screen	Screen Size W x H				Projection Distance (D)				Offset (Hd)			
	(m)		(inch)		(m)		(feet)		(m)		(feet)	
	Width	Height	Width	Height	Wide	Tele	Wide	Tele	Min.	Max.	Min.	Max.
60	1.29	0.81	50.88	31.80	1.47	2.20	4.82	7.23	-0.40	0.08	-1.32	0.26
70	1.51	0.94	59.36	37.10	1.71	2.57	5.62	8.44	-0.47	0.09	-1.55	0.31
80	1.72	1.08	67.84	42.40	1.96	2.94	6.43	9.64	-0.54	0.11	-1.77	0.35
90	1.94	1.21	76.32	47.70	2.20	3.31	7.23	10.85	-0.61	0.12	-1.99	0.40
100	2.15	1.35	84.80	53.00	2.45	3.67	8.03	12.05	-0.67	0.13	-2.21	0.44
120	2.58	1.62	101.76	63.60	2.94	4.41	9.64	14.46	-0.81	0.16	-2.65	0.53
150	3.23	2.02	127.20	79.50	3.67	5.51	12.05	18.08	-1.01	0.20	-3.31	0.66
180	3.88	2.42	152.64	95.40	4.41	6.61	14.46	21.69	-1.21	0.24	-3.97	0.79
200	4.31	2.69	169.60	106.00	4.90	7.35	16.07	24.10	-1.35	0.27	-4.42	0.88
250	5.38	3.37	212.00	132.50	6.12	9.18	20.09	30.13	-1.68	0.34	-5.52	1.10
300	6.46	4.04	254.40	159.00	7.35	11.02	24.10	36.16	-2.02	0.40	-6.62	1.32

Basic Operations

Optional Lens: AH-AC24020 / R4

Diagonal length (inch) size of 16:10 Screen	Screen Size W x H				Projection Distance (D)				Offset (Hd)			
	(m)		(inch)		(m)		(feet)		(m)		(feet)	
	Width	Height	Width	Height	Wide	Tele	Wide	Tele	Min.	Max.	Min.	Max.
60	1.29	0.81	50.88	31.80	3.06	4.65	10.04	15.27	-0.40	0.08	-1.32	0.26
70	1.51	0.94	59.36	37.10	3.57	5.43	11.72	17.81	-0.47	0.09	-1.55	0.31
80	1.72	1.08	67.84	42.40	4.08	6.20	13.39	20.35	-0.54	0.11	-1.77	0.35
90	1.94	1.21	76.32	47.70	4.59	6.98	15.07	22.90	-0.61	0.12	-1.99	0.40
100	2.15	1.35	84.80	53.00	5.10	7.76	16.74	25.44	-0.67	0.13	-2.21	0.44
120	2.58	1.62	101.76	63.60	6.12	9.31	20.09	30.53	-0.81	0.16	-2.65	0.53
150	3.23	2.02	127.20	79.50	7.65	11.63	25.11	38.16	-1.01	0.20	-3.31	0.66
180	3.88	2.42	152.64	95.40	9.18	13.96	30.13	45.80	-1.21	0.24	-3.97	0.79
200	4.31	2.69	169.60	106.00	10.20	15.51	33.48	50.89	-1.35	0.27	-4.42	0.88
250	5.38	3.37	212.00	132.50	12.76	19.39	41.85	63.61	-1.68	0.34	-5.52	1.10
300	6.46	4.04	254.40	159.00	15.31	23.27	50.22	76.33	-2.02	0.40	-6.62	1.32

Optional Lens: AH-AC23020 / R5

Diagonal length (inch) size of 16:10 Screen	Screen Size W x H				Projection Distance (D)				Offset (Hd)			
	(m)		(inch)		(m)		(feet)		(m)		(feet)	
	Width	Height	Width	Height	Wide	Tele	Wide	Tele	Min.	Max.	Min.	Max.
60	1.29	0.81	50.88	31.80	4.56	7.30	14.96	23.94	-0.40	0.08	-1.32	0.26
70	1.51	0.94	59.36	37.10	5.32	8.51	17.46	27.93	-0.47	0.09	-1.55	0.31
80	1.72	1.08	67.84	42.40	6.08	9.73	19.95	31.92	-0.54	0.11	-1.77	0.35
90	1.94	1.21	76.32	47.70	6.84	10.95	22.45	35.92	-0.61	0.12	-1.99	0.40
100	2.15	1.35	84.80	53.00	7.60	12.16	24.94	39.91	-0.67	0.13	-2.21	0.44
120	2.58	1.62	101.76	63.60	9.12	14.60	29.93	47.89	-0.81	0.16	-2.65	0.53
150	3.23	2.02	127.20	79.50	11.40	18.24	37.41	59.86	-1.01	0.20	-3.31	0.66
180	3.88	2.42	152.64	95.40	13.68	21.89	44.89	71.83	-1.21	0.24	-3.97	0.79
200	4.31	2.69	169.60	106.00	15.20	24.33	49.88	79.81	-1.35	0.27	-4.42	0.88
250	5.38	3.37	212.00	132.50	19.01	30.41	62.35	99.76	-1.68	0.34	-5.52	1.10
300	6.46	4.04	254.40	159.00	22.81	36.49	74.82	119.72	-2.02	0.40	-6.62	1.32

Basic Operations

Optional Lens: AH-AC23030 / R6

Diagonal length (inch) size of 16:10 Screen	Screen Size W x H				Projection Distance (D)				Offset (Hd)			
	(m)		(inch)		(m)		(feet)		(m)		(feet)	
	Width	Height	Width	Height	Wide	Tele	Wide	Tele	Min.	Max.	Min.	Max.
60	1.29	0.81	50.88	31.80	7.13	11.41	23.40	37.44	-0.40	0.08	-1.32	0.26
70	1.51	0.94	59.36	37.10	8.32	13.31	27.30	43.68	-0.47	0.09	-1.55	0.31
80	1.72	1.08	67.84	42.40	9.51	15.22	31.20	49.92	-0.54	0.11	-1.77	0.35
90	1.94	1.21	76.32	47.70	10.70	17.12	35.10	56.16	-0.61	0.12	-1.99	0.40
100	2.15	1.35	84.80	53.00	11.89	19.02	39.00	62.40	-0.67	0.13	-2.21	0.44
120	2.58	1.62	101.76	63.60	14.27	22.82	46.80	74.88	-0.81	0.16	-2.65	0.53
150	3.23	2.02	127.20	79.50	17.83	28.53	58.50	93.60	-1.01	0.20	-3.31	0.66
180	3.88	2.42	152.64	95.40	21.40	34.24	70.20	112.33	-1.21	0.24	-3.97	0.79
200	4.31	2.69	169.60	106.00	23.78	38.04	78.00	124.81	-1.35	0.27	-4.42	0.88
250	5.38	3.37	212.00	132.50	29.72	47.55	97.50	156.01	-1.68	0.34	-5.52	1.10
300	6.46	4.04	254.40	159.00	35.66	57.06	117.01	187.21	-2.02	0.40	-6.62	1.32

Optional Lens: AH-AC25020 / R0

Diagonal length (inch) size of 16:10 Screen	Screen Size W x H				Projection Distance (D)				Offset (Hd)			
	(m)		(inch)		(m)		(feet)		(m)		(feet)	
	Width	Height	Width	Height	Wide	Tele	Wide	Tele	Min.	Max.	Min.	Max.
70	1.51	0.94	59.36	37.10	0.59	0.59	1.94	1.94	0.24	0.24	0.77	0.77
80	1.72	1.08	67.84	42.40	0.67	0.67	2.19	2.19	0.28	0.28	0.92	0.92
90	1.94	1.21	76.32	47.70	0.74	0.74	2.43	2.43	0.32	0.32	1.07	1.07
100	2.15	1.35	84.80	53.00	0.82	0.82	2.68	2.68	0.37	0.37	1.21	1.21
120	2.58	1.62	101.76	63.60	0.97	0.97	3.18	3.18	0.46	0.46	1.51	1.51
150	3.23	2.02	127.20	79.50	1.20	1.20	3.92	3.92	0.59	0.59	1.95	1.95
180	3.88	2.42	152.64	95.40	1.42	1.42	4.67	4.67	0.73	0.73	2.39	2.39
200	4.31	2.69	169.60	106.00	1.57	1.57	5.16	5.16	0.82	0.82	2.68	2.68
250	5.38	3.37	212.00	132.50	1.95	1.95	6.41	6.41	1.04	1.04	3.41	3.41
300	6.46	4.04	254.40	159.00	2.33	2.33	7.65	7.65	1.26	1.26	4.15	4.15

Using the On Screen Display (OSD)

The Projector has a multilingual On Screen Display that allows you to make image adjustments and change a variety of settings.

How to Operate

1. To open the OSD, press “Menu” on the Control Panel or Remote Control.
2. When OSD is displayed, use ▲ ▼ keys to select any item in the main menu. While making a selection on a particular page, press “Enter” key to enter sub menu.
3. Use ▲ ▼ keys to select the desired item in the sub menu and press “Enter” key to view further settings. Adjust the settings by using ◀ ▶ key or ▲ ▼ key.
4. Select the next item to be adjusted in the sub menu and adjust as described above.
5. Press “Exit”, and the screen will return to the previous menu.
6. Press “Menu” or ◀ key to return to the main menu.
7. To exit, press “Menu” again. The OSD menu will close and the projector will automatically save the new settings.

Note

- If no button operation is made for approximately 10 seconds, the OSD will be closed automatically.

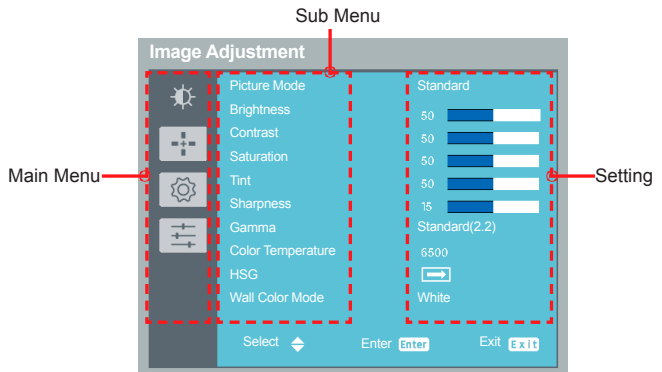

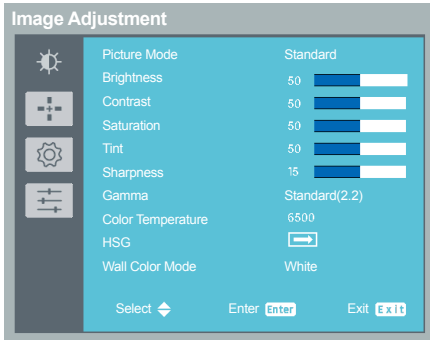

Image Adjustment

Picture Mode

There are factory presets optimized for various types of images. The available options:

- ▶ Bright: Mode for emphasizing brightness.
- ▶ Standard: Mode for optimizing the balance between brightness and color reproduction.
- ▶ Vivid: Mode for emphasizing color.
- ▶ sRGB: Mode for good color reproduction.
- ▶ DICOM SIM.: Mode for viewing DICOM format files in simulation mode, and not for the purpose of diagnosis.
- ▶ User: Mode for recalling the settings customized based on the current available picture modes.

Brightness

Adjust the brightness of the image.

- ▶ Press the ◀ key to darken image.
- ▶ Press the ▶ key to lighten the image.

Contrast

The contrast controls the degree of difference between the lightest and darkest parts of the picture. Adjusting the contrast changes the amount of black and white in the image.

- ▶ Press the ◀ key to decrease the contrast.
- ▶ Press the ▶ key to increase the contrast.

User Settings

Saturation

Adjust the color saturation of the image.

- ▶ Press the ◀ key to decrease the amount of color in the image.
- ▶ Press the ▶ key to increase the amount of color in the image.

Tint

Adjust the color balance of the image.

- ▶ Press the ◀ key to adjust the image color greenish.
- ▶ Press the ▶ key to adjust the image color reddish.

Sharpness

Adjust the sharpness of the image.

- ▶ Press the ◀ key to decrease the sharpness.
- ▶ Press the ▶ key to increase the sharpness.

Gamma

Use this function to optimize the image output.

The available options: 1.8 / 2.0 / Standard(2.2) / 2.4 / DICOM SIM.

Color Temperature

Use this function to select the preset color temperature. The

available options: 5500/6500/7500/Native.

HSG

Use this function to enhance color and reproduce vivid colors.

- ▶ On: Enable HSG.
- ▶ Off: Disable HSG.
- ▶ HSG Settings

User Settings

- Color: Use ◀ ▶ key to select a color that you wish to enhance.
When selecting Red/Green/Blue/Cyan/Magenta/Yellow, the following options are available.
 - a. Hue: Use ◀ ▶ key to change the hue of the selected color.
 - b. Saturation: Use ◀ ▶ key to change the saturation of the selected color.
 - c. Gain: Use ◀ ▶ key to change the contrast level of the selected color.When selecting White, the following options are available.
 - a. Red/Green/Blue: Use ◀ ▶ key to change the level of each color.
- Reset: Use this function to return the adjustments and settings made above to the factory default values.
- ▶ Wall Color Mode
Use this function to obtain an optimized screen image according to the wall color. The available options: White/Light Yellow/Light Blue/Pink/Dark Green.

User Settings

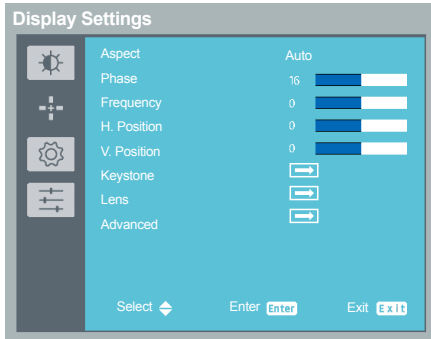

Note

- "Phase", "Frequency", "H. Position" and "V. Position" functions are only supported under Computer Signal (VGA) source.

Display Settings

Aspect

Use this function to choose your desired aspect ratio.

- ▶ Auto: Automatically selects the appropriate display format. When input is 4:3, the image is displayed as 4:3. When input is 16:9, the image is displayed as 16:9.
- ▶ 4:3/16:9/16:10/1.88:1/2.35:1: Display 4:3 / 16:9 / 16:10 / 1.88:1 / 2.35:1 aspect ratio.

Phase

Eliminate flicker from the image displayed. Use the ◀ or ▶ key to adjust the value.

Frequency

Adjust the number of total dots in one horizontal period. Use the ◀ or ▶ key to adjust number to match your PC image.

H. Position (Horizontal Position)

Shift the projected image position horizontally.

- ▶ Press the ▶ key to move the image left.
- ▶ Press the ◀ key to move the image right.

V. Position (Vertical Position)

Shift the projected image position vertically.

- ▶ Press the ◀ key to move the image down.
- ▶ Press the ▶ key to move the image up.

User Settings

Keystone

Adjust image distortion caused by tilting the projector.

- ▶ V Keystone: Adjust the vertical keystone.
- ▶ H Keystone: Adjust the horizontal keystone.
- ▶ Four Corners: Compensate for image distortion by adjusting one corner at a time.
 - a. Use the ◀ or ▶ key to select the item to select which corner to adjust and press the “Enter” key to enter its submenu.
 - b. Use the ◀, ▶, ▲, or ▼ key to adjust the setting.
- ▶ Reset: Return the keystone settings to the factory default values.

Lens

- ▶ Lens Settings
 - Lens Lock: Selecting Yes will lock all the functions provide in this menu and the Lens Centering menu. You will not be able to change lens related settings.
 - Lens Shift: Press ◀ or ▶ to select Normal Speed or Fine Tune to determine how fast you want the lens to move. After selection, press Enter to enable the lens shift function, and use ◀, ▶, ▲, or ▼ to adjust the projection position.
 - Focus: Use ◀, ▶, ▲, or ▼ to adjust the image clarity.
 - Zoom: Use ◀, ▶, ▲, or ▼ to adjust the image size.
 - Load Settings: Recalls the settings that you previously saved.
 - Save Settings: After making lens shift, zoom and focus adjustments, you can choose a set of setting to memorize current lens settings.
 - Clear Settings: Clear the selected lens setting.
- ▶ Lens Centering
 - Returns the lens to the centered position.

User Settings

Advanced

▶ RGB Input Range

Adjust the color range of the HDMI image data.

- Auto: Automatically detect RGB range.
- Limited Range: Process the input image as standard range data.
- Full Range: Select this mode when a computer signal or full range signal from AV equipment is input.

▶ Overscan

Use this function to conceal the poor picture quality in the four edges.

▶ Start-up Screen

Use this function to select an image to be displayed during the projector start up procedure. The available options: Logo/User/Off.

▶ Background on No Signal

Use this function to select a background image to be displayed when no signal is detected. The available options: Logo (User)/Blue/Black.

▶ Screen Capture

Use this function to customize the start-up screen.

- a. Project the image you want to capture.
- b. Select "Screen Capture" and press "Enter".
- c. A dialog box appears to confirm the action. Choose "Yes" to use the current image as your customized start-up screen. (Choose "No" to cancel the screen capture and exist the Onscreen Display).
- d. A message appears stating that the screen capture is in progress.
- e. When the screen capture is finished, "Screen capture succeeded!" message will pop up. If the screen capture failed, a "Screen Capture FAILED!" message will pop up. Your image size may exceed the maximum capturing capacity of 8 MB. Please change another image and try again.
- f. To use this image as the startup screen, select "User" in "Start-up Screen".

User Settings

g. To use this image as signal searching screen, select “User” in “Start-up Screen” and “Logo (User)” in “Background on No Signal”.

▶ **Test Pattern**

Use this function to display different test patterns to help you adjust the size, focus and colors and check that the projected image is free from distortion. The available options: Off/Grid/White/Color Bar/Black/Red/Green/Blue/Cyan/Yellow/Magenta.

▶ **Closed Caption**

Use this function to select a preferred closed captioning mode. Caption is an on-screen display of the dialogue, narration, and sound effects of TV programs and videos that are closed captioned (usually marked as “CC” in TV listings). The available options: Off/CC-1/CC-2/CC-3/CC-4. CC-1 displays captions in the primary language in your area.

User Settings

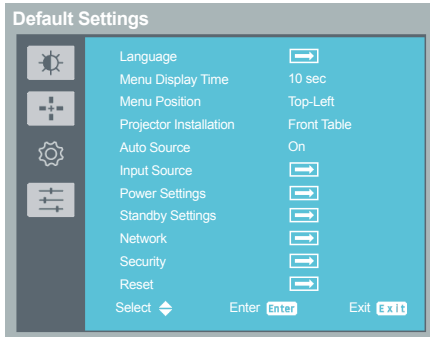

Default Settings

Language

Choose the Language for the On Screen Display menus.

English, German, French, Italian, Spanish, Traditional Chinese, Simplified Chinese, Dutch, Russia, Korean

Menu Display Time

Select the length of time the On Screen Display will remain active after your last key press.

Menu Position

Select the On Screen Display menu position.

Projector Installation

Use this function to select the projector mode, depending upon how the projector is mounted.

- ▶ Front Table: This is the default selection. The image is projected straight on the screen.
- ▶ Rear Table: When selected, the image will appear reversed.
- ▶ Rear Ceiling: When selected, the image will appear reversed in upside down position.
- ▶ Front Ceiling: When selected, the image will turn upside down.

Auto Source

When this function is turned “On”, the projector will search for other signals if the current input signal is lost. When this function is turned “Off”, it will only search a specified connection port.

Input Source





Use this option to enable/disable input sources. Press “Enter” to

enter the sub menu and select which sources you require. Press “Enter” to finalize the selection. The projector will only search for inputs that are enabled.

Power Settings

Note

- Default value of “Auto Power Off (Min)” is 20 min.

- ▶ Direct Power On: Choose “On” to activate this function. The projector will automatically power on when AC power is supplied, without pressing the  button.
- ▶ Start on Input Detection: Choose “On” to activate this function. The projector will automatically power on when a VGA signal is detected, without pressing the  button.
- ▶ Power Off Notice: When “On” is selected, a power off message will be displayed after pressing the  button. When “Off” is selected, the projector turns off after pressing the  button one time.
- ▶ Date & Time: Set the date and time for this projector.
- ▶ Auto Power Off (Min): Sets the countdown timer interval. The countdown timer will start, when there is no signal being sent to the projector. The projector will automatically power off when the countdown has finished (in minutes). When countdown timer is selected to “0”, auto power off is disabled.
- ▶ Customer Power Off (Hours): Schedule automatic shutdown of the projector.

Standby Settings

- ▶ Monitor Out
Enable/Disable the Monitor output function.
 - On: Enable the Monitor Out function at projector standby status.
 - Off: Disable the Monitor Out function at projector standby status.
- ▶ Network
Enable/Disable the network function.
 - On: Enable the network function at projector standby status.
 - Off: Disable the network function at projector standby status.
- ▶ DC 5V Out
Use this function to enable DC 5V power output through the USB-A terminal.
- ▶ HDBaseT IR Carrier
Use this function to enable HDBaseT IR Carrier.

User Settings

Network

Configure the network settings.

- ▶ Status: Display the network connection status.
- ▶ DHCP: Select On to allow the projector to obtain an IP address automatically from your network. Select “Off” to manually assign IP, Subnet Mask and Gateway configuration.
- ▶ IP Address: Set an IP address or display IP address provided from DHCP server when DHCP is set to “On”.
- ▶ Subnet Mask: Set subnet mask number or display subnet mask number provided from DHCP server when DHCP is set to “On”.
- ▶ Apply: Select “Yes” to apply the changes made in network configuration settings.
- ▶ MAC Address: Display MAC address.

Security

Configure the security settings.

- ▶ Password Protection: Select “On” to use the security verification when the turning on the projector. Select “Off” to be able to switch on the projector without password verification.
- ▶ Change Password: Set the password.
- ▶ Lock to User Startup Screen: Use this function to lock the Startup Screen and it cannot be changed by the “Start-up Screen” or “Screen Capture” function.

Reset

Return the adjustments and settings to the factory default values. Choose “Yes” to return the display parameters on all menus except Language to the factory default settings.

Note

- The default securitycode is “12345678”.

User Settings

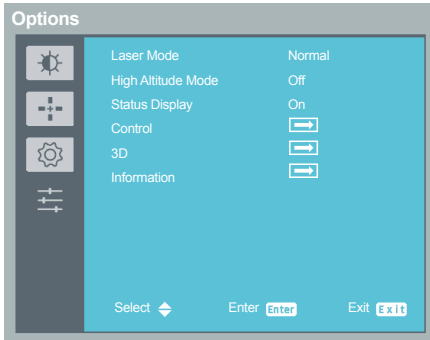

Options

Note

- When ambient temperature is over 40°C in operating, the projector will switch to “ECO” automatically.

Note

- Compatible 3D source, 3D content and Optical 3D glasses are required for 3D viewing.
- “3D Sync Invert” is only available when 3D is enabled.
- This setting may need to change when re-start running 3D movie.
- 3D function is turned on automatically when Blu-ray 3D source is input.

Laser Mode

Set the brightness mode. Choose “Normal” to increase the brightness or choose “ECO” to dim the projector light source which will lower power consumption and extend the light source life.

High Altitude Mode

When “On” is selected, the fans will spin faster. Set High Altitude mode to “On” when the projector is used over 1500m elevation.

Status Display

When “On” is selected, the status will be displayed.

Control

- ▶ HDMI CEC: Use this function for synchronized power ON/OFF operation between the projector and a CEC-compatible device connected to the HDMI/MHL port of the projector.
- ▶ Projector ID: Set the remote control ID for this projector. When multiple adjacent projectors are in operation at the same time, switching the remote control codes can prevent interference from other remote controls. After the Projector ID is set, switch to the same ID for the remote control to control this projector.
- ▶ Trigger Out: Set the port to provide trigger out function. The available options: Off/DC Out 1/DC Out 2/1 & 2.

3D

- ▶ 3D Sync: Use this option to select the appropriate 3D function.
 - DLP-Link: Choose “DLP-Link” to use DLP Link 3D Glasses.
 - External: Choose “External” to use VESA 3D emitter and 3D Glasses.

User Settings

- ▶ 3D Sync Output: Use this option to select the appropriate 3D sync output method.
 - Normal: Choose “Normal” to output 3D sync to other projector(s).
 - Pass Through: Choose “Pass Through” to receive 3D sync and/or pass 3D sync to another projector.
- ▶ 3D Format: Use this option to select the appropriate 3D format content.
 - Auto: Use this function for the projector to automatically select the 3D format depending on the 3D content.
 - Side by Side: Use this mode for “Side by Side” format 3D content.
 - Top and Bottom: Use this mode for “Top and Bottom” format 3D content.
 - Frame Sequential: Use this mode for “Frame Sequential” format 3D content.
- ▶ 3D Sync Invert: Use this option to enable/disable the 3D sync invert function.
 - Off: Choose “Off” for default frame contents.
 - On: Choose “On” to invert left and right frame contents.

Information

Display the projector information.

- ▶ Source: Display the input source that is currently connected to.
- ▶ Resolution: Display the resolution setting of the current input source.
- ▶ Picture Mode: Display current Picture Mode.
- ▶ Laser Mode: Display current Laser Mode.
- ▶ Total Time: Display the light source hours.
- ▶ Inlet Temp: Display the temperature of the intake vent.
- ▶ FW Version: Display the firmware version.

User Settings

Menu Tree

Main menu	Sub-menu	Setting	Default value	Remarks	
Image Adjustment	Picture Mode	Bright	Standard		
		Standard			
		Vivid			
		sRGB			
		DICOM SIM.			
		User			
	Brightness	0-100	50		
	Contrast	0-100	50		
	Saturation	0-100	50		
	Tint	0-100	50		
	Sharpness	0-15	8		
	Gamma	Gamma	1.8	Standard(2.2)	
			2		
			Standard (2.2)		
			2.4		
DICOM SIM.					
Color Temperature	Color Temperature	5500	6500		
		6500			
		7500			
		Native			
HSG	HSG	HSG	ON		
		HSG setting			
Wall Color Mode	Wall Color Mode	White	White		
		Light Yellow			
		Light Blue			
		Pink			
		Dark Green			
Display Setting	Aspect	Auto	Auto		
		4 : 3			
		16 : 9			
		16 : 10			
		1.88 : 1			
		2.35 : 1			
	Phase	0-31	16		
	Frequency	-10-10	0		
	H. Position	-10-10	0		
	V. Position	-10-10	0		
	Keystone	Keystone	V Keystone	0	
H Keystone			0		
Four Corners					
Reset					
Lens	Lens	Lens Setting			
		Lens Centering			

User Settings

Display Setting	Advanced	RGB Input Range	Auto	
		Overscan	Off	
		Start-up Screen	Logo	
		Background On No Signal	Logo(User)	
		Screen Capture		
		Test Pattern	Off	
		Closed Caption	Off	
Defaults Setting	Language	English	English	
		German		
		French		
		Italian		
		Spanish		
		Traditional Chinese		
		Simplified Chinese		
		Russian		
		Korean		
	Dutch			
	Menu Display Time	5 sec	10 sec	
		10 sec		
		20 sec		
		30 sec		
		always		
	Menu Position	Center	Top-Left	
		Top-Left		
		Top-Right		
		Bottom-Right		
		Bottom-Left		
	Projector Installation	Front Table	Front Table	
		Rear Table		
		Rear Ceiling		
		Front Ceiling		
	Auto Source	On	On	
		Off		
	Input Source	Computer1		
		Computer2		
HDMI 1 / MHL				
DVI-D				
Video				
S-Video				
HDBaseT				
3G-SDI				

User Settings

Defaults Setting	Power Settings	Direct Power On	Off	
		Start on Input Detection	Off	
		Power Off Notice	ON	
		Date & Time		
		Auto Power Off (Min.)	20	
		Customize Power Off (Hours)		
	Standby Setting	Monitor Out	Off	
		Network	Off	
		DC 5V Out	Off	
		HDBaseT IR Carrier	Off	
	Network	Status		
		DHCP		
		IP Address		
		Subnet Mask		
		Apply		
		MAC Address		
Security	Password Protection	Off		
	Change Password			
	Lock to User Startup Screen	Off		
Reset				
Options	Laser Mode	Normal	Normal	
		Eco		
	High Altitude Mode	On	Off	
		Off		
	Status Display	On	On	
		Off		
	Control	HDMI CEC		
		Projector ID	0	
		Trigger Out		
	3D	3D Sync		
		3D Sync Output		
		3D Format		
		3D Sync Invert		
	Information	Source		
		Resolution		
		Picture Mode		
Laser Mode				
Total Time				
Inlet Temp				
FW Version				

Wired LAN Terminal functionalities

Remote control and monitoring of a projector from a PC (or Laptop) via wired LAN is also possible.

Compatibility with Crestron control boxes enables not only collective projector management on a network

but also management from a control panel on a PC (or Laptop) browser screen.

- Crestron is a registered trademark of Crestron Electronics, Inc. of the United States.

Supported External Devices

This projector is supported by the specified commands of the Crestron Electronics controller and related

Software. The projector supports AMX and PJ-Link as well.

Model Number	RS232	LAN control (RJ45)				
	(D-sub 9pin)	Web browser	TELNET	PJ Link Ver. 1.0	Crestron	AMX
				Port number		
EK-830U.831U	✓	✓	×	✓(4352)	✓(41794)	✓(9131)

<http://www.crestron.com/>

<http://www.amx.com/>

<https://pjlink.jbmia.or.jp/english/index.html>

Controlling this Device with Web Browser

You can control this device from a PC by using a web browser.

Connecting to the Device

1. Confirmation of the IP address of the device

Go to the “Default Settings” > “Network” menu of this device, and verify the IP address.

2. Connection

Enter the IP address that was verified by opening the web browser.

For example, enter `http://192.168.0.100/` if the IP address is displayed.

Crestron

Once connected, you can control the projectors via Crestron program.

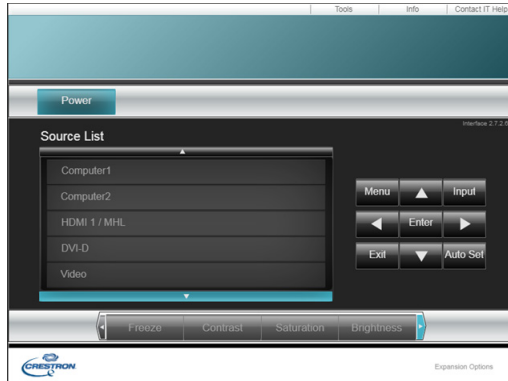

Note

- When projector is in standby mode, only the “Power” button will work.

- ▶ Power: Switch ON/OFF the power.
- ▶ Source List: Correspondence between the input display and input terminal of the device is as follows.
 - Computer
 - S-Video
 - Video
 - HDMI1/MHL
 - HDMI2
- ▶ Other buttons work in the same manner as those on the projector control panel or the remote control do.

Crestron Tools

You can manage the projector, configure the LAN control setting, and secure remote network operation on this page.

Note

- After setting the user password, you will be able to access Crestron's page by entering the password.
- After enabling the Admin password, you will be able to access the page of Crestron tool only upon entering the Admin password.

Tools | Info | Contact IT Help

Crestron Control

Ip Address: 172.30.73.164
IP ID: 7
Port: 21734
Send

Projector

Projector Name: MyProjector
Location:
Assigned To: PROJECTOR
Send

DHCP: Enabled
Ip Address: 10.82.30.82
Subnet Mask: 255.255.255.0
Default Gateway: 10.82.30.254
DNS Server: 10.82.12.11
Send

User Password

Enabled
New Password:
Confirm:
Send

Admin Password

Enabled
New Password:
Confirm:
Send

exit

CRESTRON Expansion Options

Crestron Info

This page displays information about the firmware version of the projector and status of the light source.

Note

- Crestron offers the following two types of files.
 1. RoomViewExpress_6_3_3_7.exe
 2. Xpanel.exe

Tools | Info | Contact IT Help

Projector Information

Projector Name:
Location:
Firmware Version: 1.0710.01
Mac Address: 00:80:09:00:00:01
Resolution: 960 1944
Assigned To:

Projector Status

Power Status: Power ON
Source: No Signal
Picture Mode: Standard
Projection: Standard
Laser Mode: Eco
Error Status: No Error

exit

CRESTRON Expansion Options

Regular maintenance

Note

- Unplug the AC power cord before any cleaning operation.

Clean your projector when it is contaminated by foreign matter or its display effects are getting worse.

Clean the lens

Wipe the lens with clean cloth dampened with non-abrasive camera lens cleaner or clean it with lens cleaning paper or air blower.

Do not over apply cleaner to the lens. Abrasive cleaner, solution, or other rough chemical may scratch the lens.

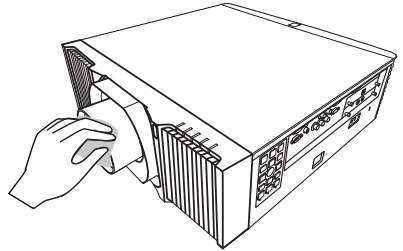

Clean casing of your projector

Wipe the casing surface with clean and soft cloth. Gently wipe the casing with clean and soft cloth dampened with small amount of neutral detergent to remove heavy dirt. Do not over apply cleaner to the casing. Abrasive cleaner, solution, or other rough chemical may scratch the casing surface.

Place your projector in proper container after use to protect it from dirt and dust and being scratched.

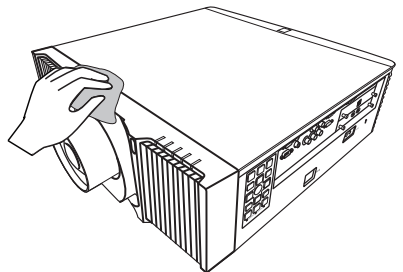

Troubleshooting

If you experience trouble with the projector, refer to the following information. If the problem persists, please contact your local dealer or service center.

Image Problem

No image appears on screen

- ▶ Ensure all the cables and power connections are correctly and securely connected as described in the “Connecting the Projector” section.
- ▶ Ensure the pins of terminals are not crooked or broken.
- ▶ Make sure you have removed the lens cap (if any) and the projector is switched on.

Partial, scrolling or incorrectly displayed image

- ▶ Press “Auto Set” on the projector’s control panel, or adjust the Display Settings > Phase / Frequency / H. Position / V. Position menu.(refer P.51)
- ▶ Adjust the computer display settings. Verify the resolution setting is less than or equal to 1920 x 1200 resolution. (refer P.51)
- ▶ If you are using a Notebook:
 1. First, follow the steps above to adjust resolution of the computer.
 2. Press the toggle output settings. For example: [Fn]+[F3]

PANASONIC, NEC => Fn+F3
HP, SHARP, TOSHIBA => Fn+F5
IBM, SONY => Fn+F7
DELL, EPSON => Fn+F8
FUJITSU => Fn+F10
APPLE =>F7

- ▶ If you experience difficulty changing resolutions or your monitor freezes, restart all equipment including the projector.

The screen of the Notebook computer is not displaying a presentation

- ▶ If you are using a Notebook PC:
Some Notebook PCs may deactivate their own screens when a second display device is in use. Each has a different way to be reactivated. Refer to your computer’s documentation for detailed information.

Image is unstable or flickering

- ▶ Adjust the “Phase” or “Clock” to correct it. Refer to the “H. Position (Horizontal Position)” or “V. Position (Vertical Position)” section for more information.(refer P.51)
- ▶ Check and reconfigure the display mode of your graphics card to make it compatible with the product.

Image is out of focus

- ▶ Adjust the Focus.
- ▶ Make sure the projection screen is between the required distance.

The image is stretched when displaying 16:9 DVD

- ▶ Change the aspect ratio by pressing the “Aspect” button on the remote control or select “Display Settings” > “Aspect” from the OSD menu to show the image with proper aspect ratio.(refer P.51)

Image is too small or too large

- ▶ Press the “Zoom” button on the remote control or go to the Display Settings > Lens > Lens Settings > Zoom menu to magnify or reduce the image size. (refer P.51)
- ▶ Move the projector closer to or further from the screen.
- ▶ Press the “Aspect” button on the remote control or go to the Display Settings > Aspect and try different settings.(refer P.51)

Image is reversed

- ▶ Go to the Default Settings > Projector Installation menu to adjust the image position.

Laser Diode Problem

No light from the projector

- ▶ Ensure all the cables and power connections are correctly and securely connected as described in the “Connecting the Projector” section.
- ▶ Ensure the pins of terminals are not crooked or broken.



The laser diode goes off































































































- ▶ Ensure all the cables and power connections are correctly.
- ▶ Check the LED indicator lighting message.(refer P.64-65)

Troubleshooting

Indicator lighting message

Note

- Steady light => 
- No light => 

Status	Indicator					
	Power		Temp	Status1	Status2	Status3
	Blue	Red	Red	Red	Red	Red
Normal Operation						
Standby						
Powering up	Flashing (0.5 sec)					
Normal (Power ON)						
Cooling		Flashing (0.5 sec)				
Firmware download						
Warning						
Timer backup error (Standby)		Flashing (0.2 sec)				
Laser fail (1 bank)						
Laser fail (2 banks)						
Laser fail (3 banks)						
Laser fail (4 banks)						
Laser fail (5 banks)						
Laser fail (6 banks)						
Laser fail (7 banks)						
Laser fail (All banks)				Flashing (0.5 sec)	Flashing (0.5 sec)	Flashing (0.5 sec)
Temperature 1 error						
Temperature 2 error						
Fan 1 error			Flashing (0.5 sec)			

Troubleshooting

Status	Indicator					
	Power		Temp	Status1	Status2	Status3
	Blue	Red	Red	Red	Red	Red
Fan 2 error			Flashing (0.5 sec)			
Fan 3 error						
Fan 4 error						
Fan 5 error						
Fan 6 error						
Fan 7 error						
Fan 8 error				Flashing (0.2 sec)		
Fan 9 error						
Fan 10 error						
Fan 11 error						
Fan 12 error						
Fan 13 error						
Fan 14 error						
Fans error						
Color wheel failure						Flashing (0.5 sec)
Phosphor wheel 1 error						Flashing (0.5 sec)
Phosphor wheel 2 error						
Liquid pump 1 error				Flashing (0.5 sec)		
Liquid pump 2 error						
Liquid pump 1 & 2 error			Flashing (0.5 sec)			

Remote Control Problem

The projector does not respond to the remote control

- ▶ Check Remote control battery.

Problem: Message Reminders

- ▶ Temperature Error - the projector is overheating inside. Check the environmental condition.

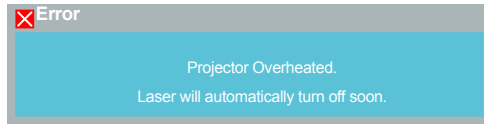

- ▶ Liquid cooler Error - the water is insufficient.

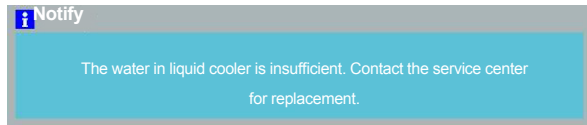

Service

- ▶ If you are unable to solve the problem, you should have the projector serviced.
- ▶ Pack the projector in the original carton. Include a description of the problem and a checklist of the steps you took when trying to fix the problem. The information may be useful to service personnel. For servicing, return the projector to the place you purchased it.

List of Compatible Signals

A. VGA Analog			
(1) VGA Analog - PC Signal			
Modes	Resolution	V.Frequency (Hz)	H.Frequency (kHz)
VGA	640 x 480	60	31.47
		72	37.86
		75	37.5
		85	43.27
		120	61.91
SVGA	800 x 600	56	35.2
		60	37.88
		72	48.08
		75	46.88
		85	53.67
		120	77.43
XGA	1024 x 768	60	48.36
		70	56.48
		75	60.02
		85	68.68
		120	98.96
SXGA	1152 x 864	70	63.85
		75	67.5
		85	77.1
	1280 x 1024	60	63.98
		72	76.97
		75	79.98
		85	91.15
QuadVGA	1280 x 960	60	60
	1280 x 960	75	75
SXGA+	1400 x 1050	60	65.32
UXGA	1600 x 1200	60	75
PowerBook G4	640 x 480	60	31.5
	640 x 480	66.6 (67)	35
	800 x 600	60	37.88
	1024 x 768	60	48.36
	1024 x 768	75	60.241
	1152 x 870	75	68.681

Appendices

A. VGA Analog			
(1) VGA Analog - PC Signal			
Modes	Resolution	V.Frequency (Hz)	H.Frequency (kHz)
WXGA	1280 x 768	60	47.78
	1280 x 768	75	60.29
	1280 x 768	85	68.63
HD 720	1280 x 720	60	45
WXGA	1280 x 800	60	49.7
	1280 x 800 - RB	120	101.6
	1440 x 900	60	55.94
WSXGA+	1680 x 1050	60	65.29
16:9	1366 x 768	60	47.71
HD 1080	1920 x 1080-RB	60	66.6
	1920 x 1080-EIA	60	67.5
WSVGA	1024 x 600	60	37.5
WUXGA	1920 x 1200-RB	59.95	74.04

B. HDMI			
(1) HDMI - PC Signal			
Modes	Resolution	V.Frequency (Hz)	H.Frequency (kHz)
VGA_60	640 x 480	59.94	31.469
VGA_72		72.809	37.861
VGA_75		75	37.5
VGA_85		85.008	43.269
VGA_120		119.518	61.91
SVGA_56	800 x 600	56.25	35.156
SVGA_60		60.317	37.879
SVGA_72		72.188	48.077
SVGA_75		75	46.875
SVGA_85		85.061	53.674
SVGA_120		119.854	77.425
XGA_60	1024 x 768	60.004	48.363
XGA_70		70.069	56.476
XGA_75		75.029	60.023
XGA_120		119.804	98.958

Appendices

B. HDMI			
(1) HDMI - PC Signal			
Modes	Resolution	V.Frequency (Hz)	H.Frequency (kHz)
SXGA_75	1152 x 864	75	67.5
SXGA_85		84.99	77.094
SXGA_60	1280 x 1024	60.02	63.981
SXGA_72		72	76.97
SXGA_75		75.025	79.976
SXGA_85		85.024	91.146
QuadVGA_75	1280 x 960	75	75
SXGA+_60	1400 x 1050	59.978	65.317
UXGA_60	1600 x 1200	60	75
Mac G4	640 x 480@60Hz	59.94	31.469
MAC13	640 x 480@67Hz	66.667	35
Mac G4	800 x 600@60Hz	60.317	37.879
Mac G4	1024 x 768@60Hz	60.004	48.363
MAC19	1024 x 768@75Hz	75.02	60.241
MAC21	1152 x 870@75Hz	75.061	68.681
WXGA_60	1280 x 768	59.87	47.776
WXGA_75		74.893	60.289
WXGA_85		84.837	68.633

Appendices

B. HDMI			
(1) HDMI - PC Signal			
Modes	Resolution	V.Frequency (Hz)	H.Frequency (kHz)
WXGA_60	1280 x 720	60	45
WXGA_60	1280 x 800	59.81	49.702
WXGA_120-RB	1280 x 800	119.909	101.563
WXGA+_60	1440 x 900	59.887	55.935
1680x1050_60	1680 x 1050	59.954	65.29
16:9	1366 x 768	59.79	47.712
1920 x 1080_RB	1920 x 1080	60	66.587
1920 x 1080_EIA	1920 x 1080	60	67.5
1920 x 1200-RB	1920 x 1200	59.95	74.038
(2) HDMI - Video Signal			
480i	720 x 480 (1440 x 480)	60	15.73
480p	720 x 480	60	31.47
576i	720 x 576 (1440 x 576)	50	15.63
576p	720 x 576	50	31.25
720p	1280 x 720	60	45
720p	1280 x 720	50	37.5
1080i	1920 x 1080	60	33.75
1080i	1920 x 1080	50	28.13
1080p	1920 x 1080	60	67.5
1080p	1920 x 1080	50	56.26
1080p	1920 x 1080	24	27
1080p	1920 x 1080	23.98	26.97
1080p	1920 x 1080	24	27
1080p	1920 x 1080	23.98	26.97
C. MHL			
(1) MHL - Video Signal			
Modes	Resolution	V.Frequency (Hz)	H.Frequency (kHz)
480i	720 x 480 (1440 x 480)	60	15.73
480p	720 x 480	60	31.47
576i	720 x 576 (1440 x 576)	50	15.63
576p	720 x 576	50	31.25

Appendices

C. MHL			
(1) MHL - Video Signal			
Modes	Resolution	V.Frequency (Hz)	H.Frequency (kHz)
720p	1280 x 720	60	45
720p	1280 x 720	50	37.5
1080i	1920 x 1080	60	33.75
1080i	1920 x 1080	50	28.13
1080p	1920 x 1080	24	27
1080p	1920 x 1080	23.98	26.97
1080p	1920 x 1080	30	33.75

D. YPbPr			
Modes	Resolution	V.Frequency (Hz)	H.Frequency (kHz)
480i	720 x 480	59.94	15.73
480p	720 x 480	59.94	31.47
576i	720 x 576	50	15.63
576p	720 x 576	50	31.25
720p	1280 x 720	60	45
720p	1280 x 720	50	37.5
1080i	1920 x 1080	60	33.75
1080i	1920 x 1080	50	28.13
1080p	1920 x 1080	60	67.5
1080p	1920 x 1080	50	56.26
1080p	1920 x 1080	24	27
1080p	1920 x 1080	23.98	26.97

E. Video, S-Video			
Modes	Resolution	V.Frequency (Hz)	H.Frequency (kHz)
NTSC	15.73	60	3.58
PAL	15.63	50	4.43
SECAM	15.63	50	4.25 or 4.41
PAL-M	15.73	60	3.58
PAL-N	15.63	50	3.58
PAL-60	15.73	60	4.43

Appendices

E. Video, S-Video			
Modes	Resolution	V.Frequency (Hz)	H.Frequency (kHz)
NTSC4.43	15.73	60	4.43

F. 3D Timming				
Input Resolutions	HDMI 3D Input (with 3D Info Frame information)	Input timing		
		1280 X 720P @ 50Hz	Top - and - Bottom	
		1280 X 720P @ 60Hz	Top - and - Bottom	
		1280 X 720P @ 50Hz	Frame packing	
		1280 X 720P @ 60Hz	Frame packing	
		1920 X 1080i @ 50 Hz	Side- by-Side (Half)	
		1920 X 1080i @ 60 Hz	Side- by-Side (Half)	
		1920 X 1080P @ 24 Hz	Top - and – Bottom	
	1920 X 1080P @ 24 Hz	Frame packing		
	HDMI 3D Input (without 3D Info Frame information)	1920 x 1080i @ 50Hz	Side-by-Side (Half)	SBS mode is on
		1920 x 1080i @ 60Hz		
		1280 x 720P @ 50Hz	Top-and-Bottom	TAB mode is on
		1280 x 720P @ 60Hz		
		1920 x 1080i @ 50Hz		
		1920 x 1080i @ 60Hz		
		1280 x 720P @ 50Hz	480i	HQFS
	1280 x 720P @ 60Hz			
	VGA (PC)	800x600 @ 60Hz	SBS or TAB	
		1024x768 @ 60Hz	Frame Sequential	
		800x600 @ 120Hz		
1024x768 @ 120Hz				
Composite	NTSC	HQFS		
S-Video	NTSC	HQFS		

Configurations of Terminals

Terminal: Computer In (Mini D-sub 15 pin) [Monitor Out]

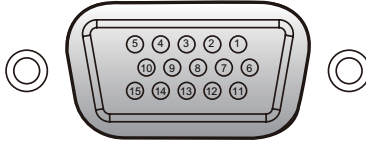

1	Red (R/Cr) Input [R Output]	9	DDC 5V [NC*]
2	Green (G/Y) Input [G Output]	10	Ground (Ver. sync.)
3	Blue (B/Cb) Input [B Output]	11	NC*
4	NC*	12	DDC Data [NC*]
5	Ground (Horiz.sync.)	13	Horiz. sync. Input [Output] (Composite H/ V sync. Input)
6	Ground (Red)		
7	Ground (Green)	14	Vert. sync. Input [Output]
8	Ground (Blue)	15	DDC CLK [NC*]

*Do not connect anything.

Terminal: PC Control (D-sub 9 pin) (male)

Note

- Contact your dealer for control cable and commands.

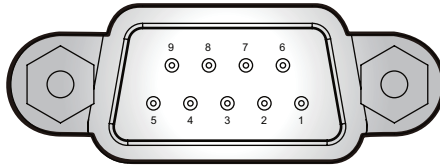

1	NC*	6	NC*
2	RXD (Receiving Data)	7	NC*
3	TXD (Sending Data)	8	NC*
4	NC*	9	NC*
5	GND	* Do not connect anything.	

Terminal: 3D Sync

Note

- Contact your dealer for control cable and commands.

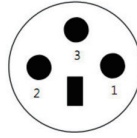

1	+5VDC
2	GND
3	Stereo Sync

TTL Signal	Parameter
high" state ≥ 2.4 V for left-eye image	≥ 2.4 v
low" state ≤ 0.8 V for right-eye image;	≤ 0.8 v
Duty cycle	50%

Terminal: 12V Trigger Out

Note

- Contact your dealer for control cable.

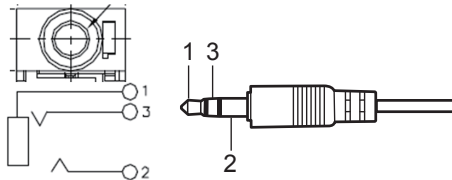

1	GND
2	12V
3	NC

Terminal: Wired Remote In/Out

Note

- Contact your dealer for control cable.

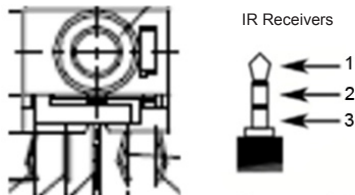

1	5V
2	IR signal (NEC Format)
3	Ground

Specifications

Mechanical properties

Dimensions (W×H×D)	548mmx554.2mmx189mm (without lens)
Net Weight	26.5 ± 0.5Kg (without lens)
Adjustable foot	Max. Height to 26.5mm

LCD resolution

LCD system	0.67" TFT
LCD resolution	1920X1200

Compatible signals

Color standard	PAL, SECAM, NTSC, NTSC4.43, PAL-60, PAL-M and PAL-N
HDTV signal	480i, 480p, 576i, 576p, 720p, 1080p and 1080i
Scanning frequency	Horizontal frequency: 15–100 KHz; Vertical frequency: 24–120 Hz

Optical elements

Image size (diagonal lines)	60"-300"
Projection distance	Wide: 2.08m ~ 10.41m / Tele: 3.12m ~ 15.61m(with Standard Lens)
Lens (Standard Lens)	F = 1.6~2.0 / f =24.1~35.8mm; Zoom ratio: 1.5x
Contrast Ratio	Infinity with Dynamic Black mode
Aspect Ratio	16:10

Terminal

S-Video	S-Video Mini Din 4pin x1
BNC / Component	BNC x 5 (G or Y, B or Pb, R or Pr, H and V)
Video	RCA x1
DVI-D	24pin DVI-D
Computer IN	Mini D-sub 15 pin x1
Monitor OUT	Mini D-sub 15 pin x1
HDMI (MHL)	HDMI Type A x1
DC 5V OUT	USB type A x1
12V Trigger Out	3.5mm Mini Jack Stereo x22
USB-B	Mini USB type B x1
Wired remote control input terminal	Mini Jack, 3.5mm x1
Wired remote control output terminal	Mini Jack, 3.5mm x1
RS232 Input	D-sub 9 pin x1
RS232 Output	D-sub 9 pin x1
HDBaseT terminal	RJ45 x1
3G-SDI Input	BNC x1
3G-SDI Output	BNC x1
LAN terminal	RJ45 x1, 100 Base-TX (100Mbps)/10 Base-T (10Mbps)
3D sync Input	3 pin mini DIN receptacle
3D sync Output	3 pin mini DIN receptacle

Power

Power supply	AC 100–240 V, 50/60 Hz
--------------	------------------------

Operating Environment

Operating temperature	32°F-104°F (0°C-40°C)
Storage Temperature	14°F-149°F (-10°C-60°C)
High land	3000 m

Remote control

Battery	AAA 1.5V ALKALINE TYPE x 2
Operating Range	23.0' (7m) / ±30° (horizontally) / ±20° (vertically)
Dimensions	46mm (W) x 175mm (H) x 21mm (D)
Net Weight	75g (without batteries)

Accessories

Safety Guide	AC power cord (US Type x 1 / Euro Type x 1)
Quick Start Guide	VGA cable
Remote control and batteries	

- Designs and specifications are subject to change without notice.
- This model may not be compatible with features and/or specifications that may be added in the future.

Cabinet Dimensions

Unit: mm

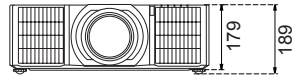
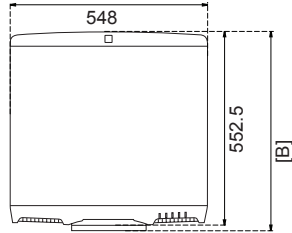

Holes for ceiling mount
Screw type: M6

Thread the screw into
the hole for 8mm (min.)
to 10mm (max.) thick.

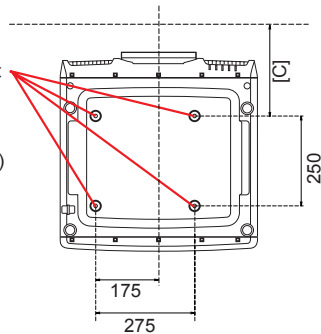

[B] and [C] differ when different lens are installed.

Lens installed	[B]	[C]
AH-AC21020	594	216
AH-AC22060	610	232
AH-AC22070	611	233
AH-AC24020	632	253
AH-AC23020	632	253
AH-AC23030	632	253
AH-AC25020	815	436.2

Trademarks

- DLP is trademarks or registered trademark of Texas Instruments.
- Microsoft, Windows, Windows Vista, Internet Explorer and PowerPoint are either a registered trademark or trademark of Microsoft Corporation in the United States and/or other countries.
- HDMI, the HDMI Logo and High-Definition Multimedia Interface are trademarks or registered trademarks of HDMI Licensing LLC.



- MHL, Mobile High-Definition Link, and MHL Logo are trademarks or registered trademarks of MHL, LLC.
- Kensington is a trademark or registered trademark of ACCO Brands.
- Blu-ray is a trademark of Blu-ray Association.
- HDBaseT™ and the HDBaseT Alliance logo are trademarks of the HDBaseT Alliance.
- Other product and company names mentioned in this user's manual may be the trademarks or registered trademarks of their respective holders.



U.S.A.

EIKI International, Inc.
30251 Esperanza
Rancho Santa Margarita
CA 92688-2132, U.S.A.
Tel: +1 800-242-3454
+1 949-457-0200
Fax: +1 800-457-3454
+1 949-457-7878
E-Mail: usa@eiki.com

Deutschland & Österreich

EIKI Deutschland GmbH
Am Frauwald 12
65510 Idstein, Deutschland
Tel: +49 6126-9371-0
Fax: +49 6126-9371-11
E-Mail: info@eiki.de

China

EIKI (Shanghai) Co., Ltd.
LAKESIDE OASIS MIDDLE RING
BUSINESS CENTRE
Block 1, Room 606,
1628, Jin Sha Jiang Road
Shanghai, 200333, CHINA
China
Tel: +86 21-3251-3993
Service Hot line: +86 21-3251-3995
Fax: +86 21-3251-3997
E-mail: info@eiki-china.com

Oceania

EIKI AUSTRALIA PTY LTD
Level 5, 11 Queens Road,
Melbourne, Victoria 3004, Australia
Tel: +61 03-8530-7048
Fax: +61 03-9820-5834
E-Mail: sales@eiki.net.au

Canada

EIKI CANADA
EIKI International, Inc.
Canadian Branch
9170 County Road 93, Suite 304,
Midland, ON, L4R 4K4, Canada
Tel: +1 800-563-3454
+1 705-527-4084
E-Mail: canada@eiki.com

Eastern Europe

EIKI CZECH SPOL. s.r.o.
Nad Cementárnou 1163/4a
Praha 4, Podolí, 147 00
Czech Republic
Tel: +420 241-410-928
+420 241-403-095
Fax: +420 241-409-435
E-Mail: info@eiki.cz

South East Asia

EIKI Industrial (M) Sdn Bhd
No. 11, Nouvelle Industrial Park,
Lorong Teknologi B, Taman Sains
Selangor 1, Kota Damansara PJU5,
47810 Petaling Jaya,
Selangor Darul Ehsan, Malaysia
Tel: +60 3-6157-9330
Fax: +60 3-6157-1320
E-Mail: sales@eiki.my

Japan & Worldwide

EIKI Industrial Company Limited.
6-23 Teramoto, Itami-shi, Hyogo,
664-0026, Japan
Tel: +81 72-782-7492
Fax: +81 72-781-5435

World Wide Website <https://global.eiki.com/>