

## HDMI Matrix Switcher Series

**ITEM NO.: HS10M-4K6G 10 x 10 HDMI Matrix Switcher**

**HS10M-4K6G is a true 4K HDMI Matrix Switcher** which allows to route any of 10 HDMI sources to any 10 HDMI displays! The **10x10 HDMI Matrix switch** is a complete HDMI routing solution for True 4K HDMI systems. It supports resolution up to **4K 60Hz @ 4:4:4** and effortless control through Ethernet control, Android App Control, IR remote control, RS-232 and the front panel.



### Features:

- Connects up to 10 HDMI sources to 10 HDMI display monitors.
- HDMI 2.0 with 3D, HDCP 2.2 & DVI1.1 Compliant.
- Ultra-high-definition video up to 4K 60Hz @ 4:4:4 18Gbps (6Gbps per color)
- Support HDR10, Dolby Vision, HLG
- Supports up to, Dolby TrueHD, Dolby ATMOS, DTS-HD MA, DTS:X, LPCM 7.1 @ 192KHz
- Supports ARC (Audio Return Channel) function.
- Multiple control methods: Front panel buttons/ IR remote control/ WebGUI Control/ iOS/Android App Control and RS232 Control.
- Built-in LCM screen & LED button at front panel provides quick view of all port connection.
- Rack mountable( 1U design)
- S/PDIF coaxial audio outputs allow audio to be de-embedded from HDMI outputs
- Support HDMI cable lock on each HDMI input/output port

## Front Panel View:

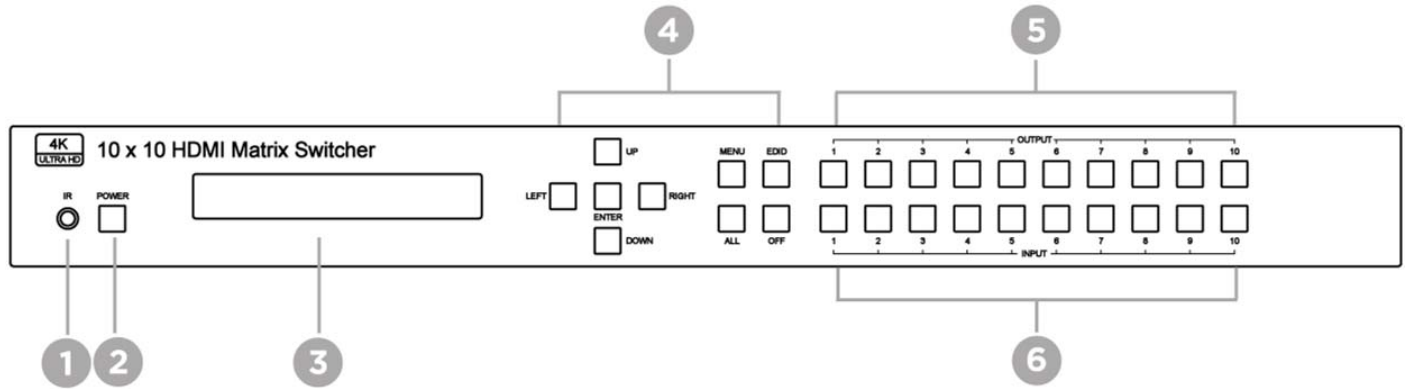

No.	Feature	LED Status	Description
1	IR receiver	N/A	Receiving IR remote signal
2	POWER	Blue ON	Power ON
		Red ON	Standby
3	LCM Display	N/A	Display operating status or Menu.
4	UP Button	N/A	Go up direction in Menu.
	DOWN Button		Go down direction in Menu.
	LEFT Button		Go left direction in Menu.
	RIGHT Button		Go right direction in Menu.
	ENTER Button		Execute selected function
	MENU Button	Blue ON	Press to enter Menu or display current operating status Press and hold 3 seconds to enable/disable KEYLOCK
	SCENE Button		Save/Load scene
	ALL Button		Select all output
	OFF Button		Turn off select output
5	OUTPUT Buttons	Blue ON	Press these buttons to select the desired output Monitor connected
		OFF	No monitor connected
6	INPUT Buttons	Blue ON	Press these buttons to select the desired input Video input detected
		OFF	No video input

## Rear Panel View:

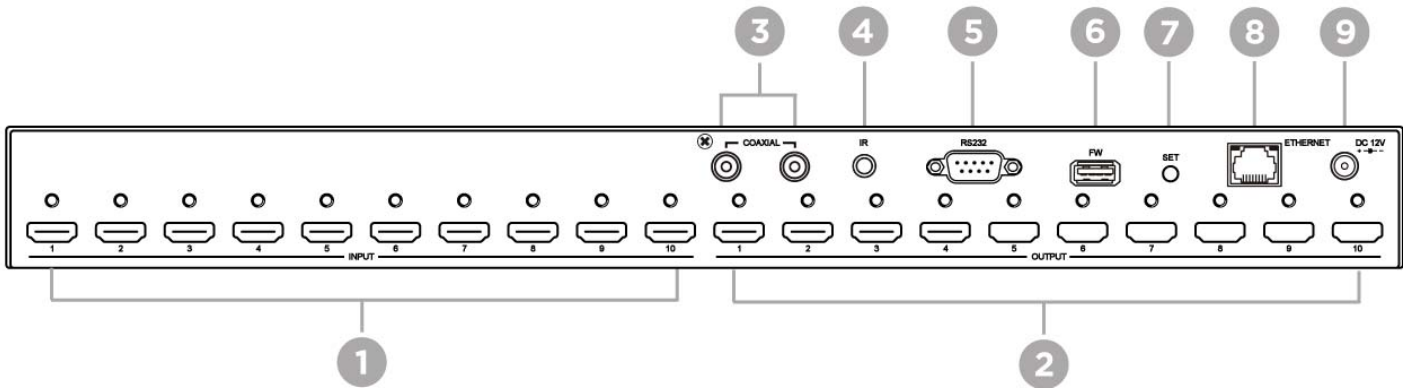

1	INPUT HDMI	N/A	HDMI input port 1~10
	OUTPUT HDMI	N/A	HDMI output port 1~10
3	SPDIF	N/A	SPDIF audio output port 1~2
4	IR	N/A	External IR receiver
5	CONSOLE	N/A	RS232 command control / Firmware update
6	FW	N/A	Firmware update
7	SET	N/A	
8	RJ45	N/A	WEB control interface
9	DC JACK	N/A	Power input
Notice	* In standby mode, IR remote cannot control matrix but power on matrix only * Please press ENTER to execution any change of menu settings		

## 2.0 HS10M-4K6G Connection View:

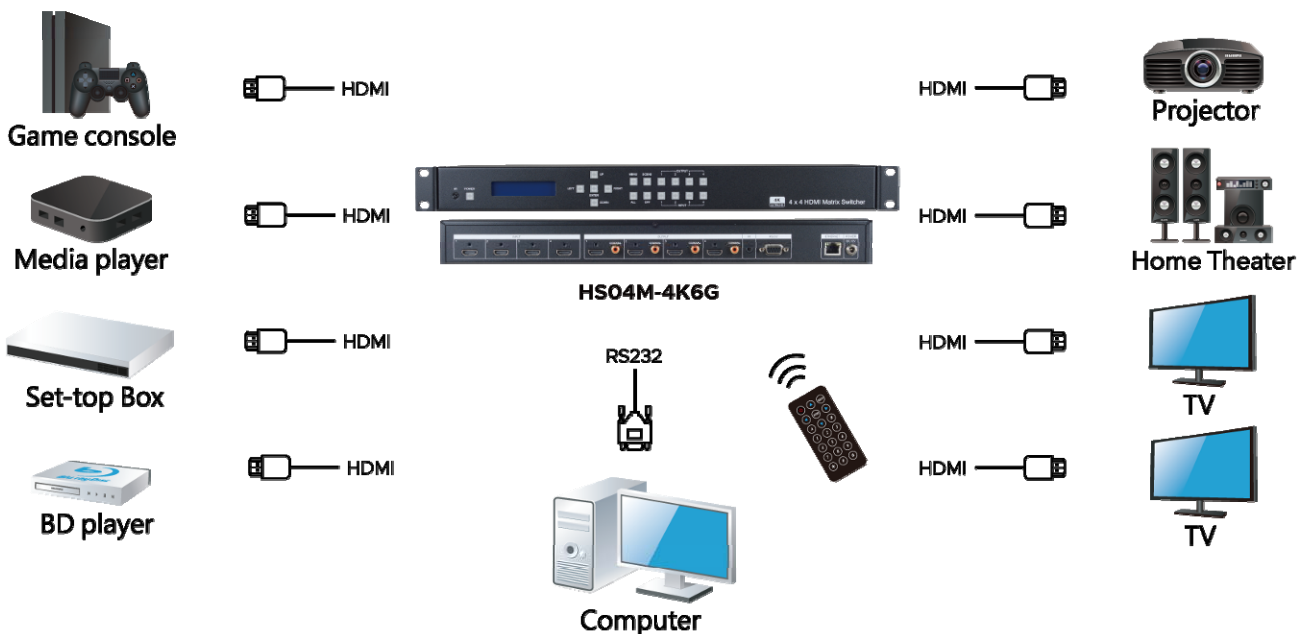

### 3.0 Panel Function:

#### Power on Main Screen

```
HDMI 2.0 10X10 MATRIX
Version V1.01
```

After power on, the main screen will show matrix name and version information.

The matrix will back to main screen if no operations in 30 seconds

#### Channel Switching:

```
OUT  1 2 3 4 5 6 7 8 9 10
IN   1 2 3 4 5 6 7 8 9 10
```

Press OUTPUT 1~10 to select HDMI output (multiple selections) then press INPUT 1~10 (single selection) then press ENTER to execute.

#### SCENE Button:

```
OUTPUT → SAVE
INPUT  → LOAD
```

Press SCENE button then press INPUT 1 ~ 10 to load the pre-stored scenes, or press OUTPUT 1 ~ 10 to save the current channel settings to a total of 10 scenes then press ENTER to execute

#### ALL Button:

```
OUT  1 2 3 4 5 6 7 8 9 10
IN   1 1 1 1 1 1 1 1 1 1
```

Press ALL button and the number on the second line of IN will flash. Press INPUT 1 ~ 10 to select input port or OFF button to turn off all output then press ENTER to execute.

#### OFF Button:

```
OUT  1 2 3 4 5 6 7 8 9 10
IN   X X X X X X X X X X
```

Press OUTPUT 1 ~ 10 then press OFF to turn off the selected output, or ALL to turn off all outputs then press ENTER to execute.

#### Key Lock:

```
KEYLOCK!
```

Press MENU button for 10 seconds to enable/disable key lock function.

#### Main Menu:

```
* 1 - SWITCH
  2 - SCENE
```

Press MENU button to enter main menu

#### Operation:

- Press UP or DOWN key to move \* to select an item for setting and press ENTER key to enter into subpage.
- When the selected sub-page setting is completed, press the MENU button to return to the main page

## 4.0 LCM Main MENU Function Operations:

### 4.1 SWITCH : (Default: 1 2 3 4 5 6 7 8 9 10)

OUTPUT	1	2	3	4	5	6	7	8	9	10
INPUT	1	2	3	4	5	6	7	8	9	10

This function is used to switch the input/output port. Enter the SWITCH menu. Press the ENTER key, then the LCM second line INPUT will flash. Press LEFT or RIGHT button to select the output to be modified. Then press UP or Down button to select the input port. After that, press ENTER to confirm setting.

### 4.2 SCENE

OUTPUT	→	SAVE
INPUT	→	LOAD

SCENE function provide 10 sets of channel setting to fast reload for different application.

### SAVE

SAV	1H2H	3	4	5	6	7	8	9	10	
#01	3	2	3	4	5	6	7	8	9	10

Save current channel setting, press UP or DOWN to select the number and ENTER to save. It will show input number and status of audio selection.

### LOAD

LOD	1A2H	3	4	5	6	7	8	9	10
#01	3	1	3	4	5	5	5	5	5

Reload saved scenes, press UP or DOWN to select the number and ENTER to load. It will show input number and status of audio selection.

At main screen you could use IR01 remote button **B** to enter SCENE function, button **1~0** to select port number 1~10 to load.

### 4.3 EDID: (Default: LPCM-2CH)

Because the player output display resolution will be based on TV EDID, this Matrix provides two default EDID modes: " BUILD-IN MODE" and "COPY MODE".

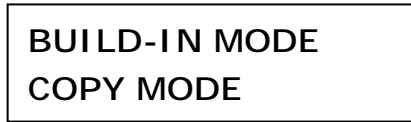

#### 4.3.1 BUILD-IN MODE:

This mode supports video resolution up to 4K 60Hz, audio format support LPCM-2CH · LPCM-7.1 · AC3 · DTS. After enter BUILD-IN MODE menu, press UP or DOWN key to select then press ENTER to confirm setting.

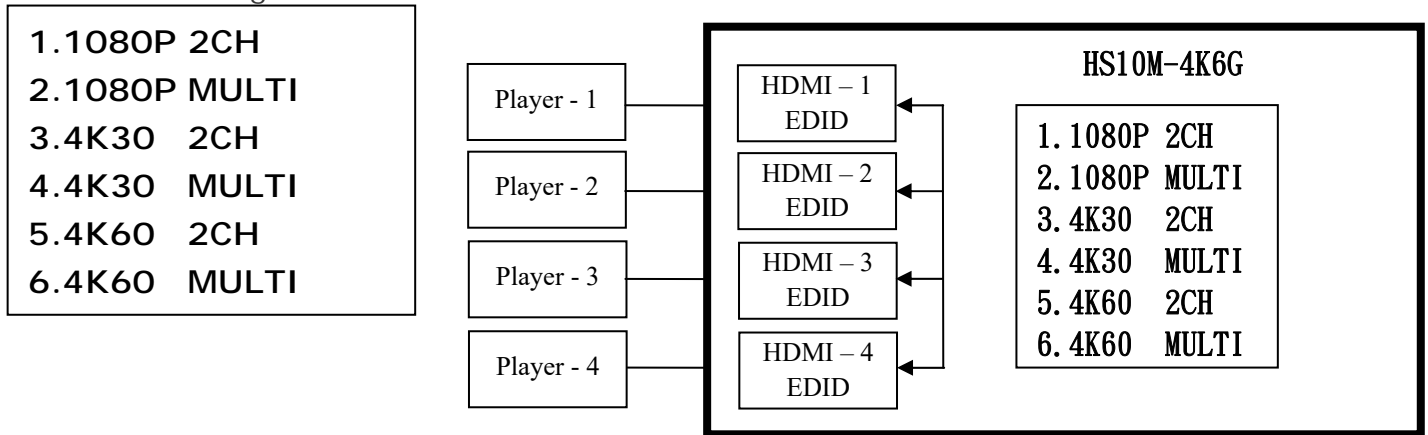

#### 4.3.2 COPY MODE :

To fully support the TV resolution and audio mode, the matrix provides "copy mode" to copy TV EDID for input source reference. When use the copy mode, recommend copying the lowest resolution TV EDID. Otherwise it may cause no picture display if the TV resolution is not able to support higher resolution.

After entering COPY MODE menu, press UP or DOWN button to select the OUTPUT (1 to 4) and press ENTER, then press UP or DOWN button to select the INPUT (1 to 4 or ALL) and press ENTER to confirm. **If selected output not connected with monitor it will show "NO OUTX HPD" and return to upper menu when press ENTER.**

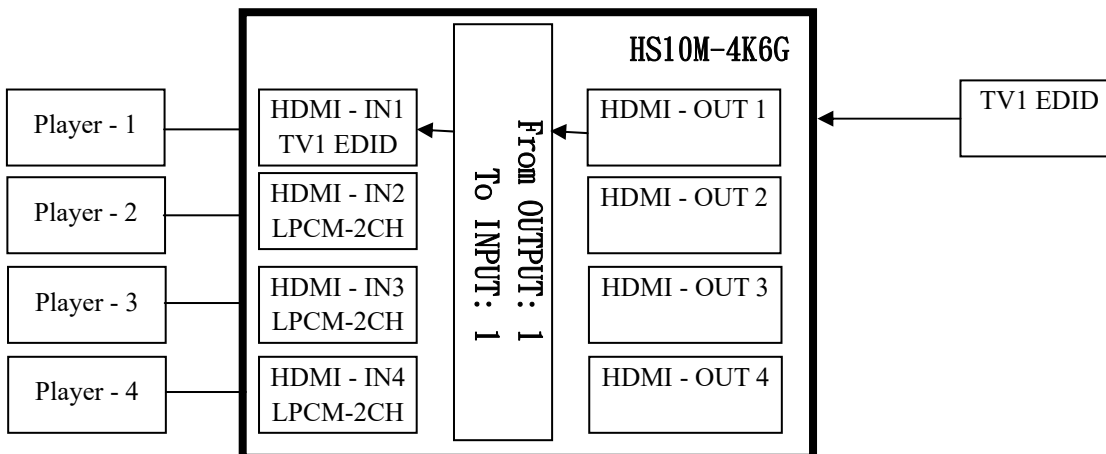
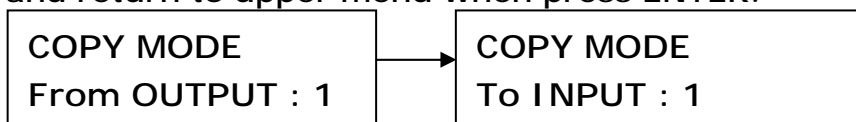

It will show "EDID Write ERROR" if update failed, or "EDID Write OK" if success.

#### 4.4 Ethernet

This function can change the network settings of the matrix. Press UP or DOWN key to move \* to select an item for setting and press ENTER key to enter into subpage. When the selected sub-page setting is completed, press the MENU button to return to the main page

##### IP Address: (Default: 192.168.0.10)

<b>IP Address</b> 192.168. 0.10
------------------------------------

This function can be setup MATRIX host intranet "IP Address", press the ENTER, the left-most number of second row will flash, then press the UP or DOWN button to change the numbers, , press LEFT or RIGHT to move to another location, the move to a position number will flash, press ENTER to complete the setting.

##### Subnet Mask: (Default 255.255.255.0)

<b>Subnet Mask</b> 255.255.255.000
---------------------------------------

This function can be setup MATRIX host intranet "Subnet Mask", press the ENTER, the left-most number of second row will flash, then press the UP or DOWN button to change the numbers Press the ENTER, , press LEFT or RIGHT to move to another location, the move to a position number will flash, press ENTER to complete the setting.

##### Gateway: (Default 192.168.0.1)

<b>Gateway</b> 192.168. 0. 1
---------------------------------

This function can be setup MATRIX host intranet "Gateway", press the ENTER, the left-most number of second row will flash, then press the UP or DOWN button to change the numbers Press the ENTER, , press LEFT or RIGHT to move to another location, the move to a position number will flash, press ENTER to complete the setting.

##### DHCP Client: (Default Disable)

<b>DHCP Client</b> Disable
-------------------------------

<b>DHCP Client</b> Enable
------------------------------

When DHCP Clients setup at "Enable", the MATRIX host will automatically get IP Address, Subnet Mask, Gateway, if setup at "Disable", the MATRIX Host IP Address need go through "ETHERNET" menu to set IP Address, Subnet Mask, Gateway, to press the ENTER, the second row will flash, then press the UP or DOWN to select DISABLE, ENABLE, then press ENTER to complete the setting.

##### Media Type: (Default 100M)

<b>Media Type</b> 100M
---------------------------

<b>Media Type</b> AUTO
---------------------------

<b>Media Type</b> 10M
--------------------------

This function can be setup MATRIX host intranet "Media Type, press the ENTER, the second row will flash, then press the UP or DOWN button to select 10M, 100M, AUTO, press ENTER to complete the setting.

##### MAC Filter : (Default Disable)

<b>MAC FILTER</b> DISABLE
------------------------------

<b>MAC FILTER</b> ENABLE
-----------------------------

MAC Filter can be setup with registered MAC Address in order to connect the MATRIX host Web UI, MAC Address required by the Web page to fill in, this function can only be setup at "DISABLE", "ENABLE", then to press the ENTER, the second row will flash, then press the UP or DOWN to select DISABLE, ENABLE, then press ENTER to complete the setting.

## 4.5 REMOTE ID : (Default ID 4)

This function must be set to match the Matrix remote control IR01 with the matrix itself. A conflict with other devices remote control is avoided.

After entering REMOTE ID menu, press ENTER, the LCM LINE 1 number will flash. Then Press UP or DOWN button to select the number, and then press ENTER to confirm.

When finish REMOTE ID setting, MATRIX remote control IR01 must also set the same ID in order to operation in normal.

IR Remote setting: Press and hold the POWER button, then press the number button which can be set from 0 to 9, total 10 groups.

These settings on IR01 remote control have to be done the first time you use the IR01 or when you change the batteries.

REMOTE ID	4
-----------	---

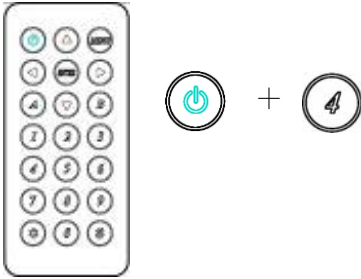

## 4.6 AUDIO SELECT: (Default H)

This function can set the output of SPDIF to HDMI (H) or ARC (A).

OUTPUT	1 2
AUDIO	H H

## 4.7 SYSTEM INFO:

Display HS10M-4K6G Matrix firmware version

* 1.MAIN	V1.00	8. IN5	V1.00	16.OUT3	V1.00
2.WEB	V1.00	9. IN6	V1.00	17.OUT4	V1.00
3.CPLD	V1.00	10.IN7	V1.00	18.OUT5	V1.00
4.IN1	V1.00	11.IN8	V1.00	19.OUT6	V1.00
5.IN2	V1.00	12.IN9	V1.00	20.OUT7	V1.00
6.IN3	V1.00	13.IN10	V1.00	21.OUT8	V1.00
7.IN4	V1.00	14.OUT1	V1.00	22.OUT9	V1.00
8.IN5	V1.00	15.OUT2	V1.00	23.OUT10	V1.00

## 4.8 USB UPDATE :

Update on boot:

Connect the USB flash drive, select USB UPDATE, and press ENTER to execute the FW update. When the screen turns dark during the update, the screen will display "FIRMWARE UPDATE PLEASE WAIT". After completion, it will restart to the boot screen.

Update in standby mode: :

Connect the USB flash drive, press and hold the SET button in back panel, connect the power then release the button after 2 seconds, it will automatically update and reboot to the startup screen after completion.



## 5.0 Remote Control Function (IR01):

5.1 To command the matrix locally, setup the remote control IR01 ID same with the Matrix (see 4.5). The default code is 4. (Power+4)

5.2 Warning: These settings have to be done the first time you use the IR01 or when you change the batteries.

- IR ID setup : press and hold POWER button , then press Number key

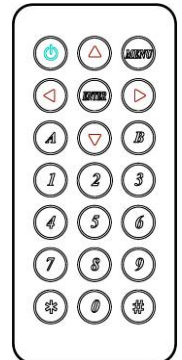

### Remote control button define:

Symbol	Function
	Power on/Standby
	LEFT
	RIGHT
	UP
	DOWN
	ENTER
	MENU
	ALL
	LOAD SCENE
	Quick key 1
	Quick key 2
	Quick key 3
	Quick key 4
	Quick key 5
	Quick key 6
	Quick key 7
	Quick key 8
	Quick key 9
	OFF
	Quick key 10

### Quick key:

For example: to switch output port 1 to input port 4, press 1 (OUTPUT 1) and then press 4 (INPUT 4).

\* Under using quick key operation, LCM screen will jump to the output / input setting page; it won't allow using the front panel button to operate the HS10M-4K6G Matrix.

## 6.0 Remote Control Function : ( CONSOLE )

HS10M-4K6G support RS232 and TCP/IP control by commands as below:

6.1

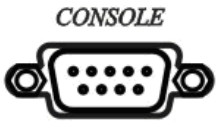

### For RS232 CONSOLE:

Connect the RS232 CONSOLE port to the COM port of the host by a F/M RS232 straight cable (pin 2 to pin 2; pin 3 to pin 3, pin 5 to pin 5).

**Communication format is 9600,8, N, 1 (9600 bps, 8 data bits, no parity check, 1 stop bit)**



**For Ethernet TCP/IP(Winsock): Default IP address: 192.168.0.10, Port:47011**

## 6.2 Operation Instruction format:

Command + △(Space) + Parameter + Enter

[Command]	[Description]
POWER△[d]	Power on/off
TX01△[b]	Set Input #n to output 1
TX02△[b]	Set Input #n to output 2
TX03△[b]	Set Input #n to output 3
TX04△[b]	Set Input #n to output 4
TX05△[b]	Set Input #n to output 5
TX06△[b]	Set Input #n to output 6
TX07△[b]	Set Input #n to output 7
TX08△[b]	Set Input #n to output 8
TX09△[b]	Set Input #n to output 9
TX10△[b]	Set Input #n to output 10
IR_ID△[i]	Set IR remote ID
SAVE△[a]	Save scene to #n
LOAD△[a]	Load scene from #n
LOCK△[d]	Panel button& IR remote control Lock/Unlock
SET_DHCP△[d]	DHCP client on/off

IPADDRESS△[n.n.n.n]	Set Matrix IP address
SUBNETMASK△[n.n.n.n]	Set Matrix subnet mask
GATEWAY△[n.n.n.n]	Set Matrix gateway
MEDIATYPE△[m]	Network speed select
MACFILTER△[d]	MAC filter on/off
STATUS	Show connection status
VERSION	Show firmware version
HELP	Help

[Symbol]	[Parameter]
a	00~10
b	00=off, 01~10
d	00=off, 01=on
i	00~09=0~9
m	00=auto, 01=10M, 02=100M
n	0~255

#### Example:

-To route input 4 to output 1, send the following string:

TX1△04[Enter]

(HEX code: 54 58 30 31 20 30 34 0D)

-To put in standby the matrix, send the following string:

POWER△00[Enter]

(HEX code: 50 4F 57 45 52 20 30 30 0D)

Commands are **case insensitive**.

The Matrix will reply **OK** once string is correct, **NG** in case of incorrect string

## 7. Ethernet Control Function:

### Initial IP Configuration

1. Setup MATRIX IP Address same as your PC with same domains.(Default 192.168.0.10)  
MATRIX IP Address method, please refer. to “ETHERNET” Chapter
2. Input IP Address on a web page, you could link to the Web UI of the MATRIX host.
3. Web UI Operation :

### SWITCH SETTING:

**HDMI 2.0 10x10 MATRIX**

**SWITCH SETTING**

MATRIX-01

Power	Output	Input
Power On ▼	Output 1	Input 1 ▼
	Output 2	Input 2 ▼
	Output 3	Input 3 ▼
	Output 4	Input 4 ▼
	Output 5	Input 5 ▼
	Output 6	Input 6 ▼
	Output 7	Input 7 ▼
	Output 8	Input 8 ▼
	Output 9	Input 9 ▼
	Output 10	Input 10 ▼
	All port	NA ▼

Reload

Advanced

Apply

Version V1.01

- **Power** : Control MATRIX power on and standby.
- **Output** : Display output 1~10, it can change the display name by the Aliases page.
- **Input** : Display input 1~10, this field is a drop down menu, this field is a drop-down menu, a drop-down menu include Input 1 ~ 10 and OFF, It can change the display name by the Aliases page.
- **Reload** : Get MATRIX host message.
- **Advanced** : Enter into the “Advanced” page.
- **Apply** : Complete the setting
- **All Port** : Set all output from input 1~10 or off at once.

Advanced:

**HDMI 2.0 10x10 Matrix**

**Advanced**

IP address	192.168.0.10
Subnet mask	255.255.255.0
Gateway IP	192.168.0.1
Media Type	Auto detect ▼
DHCP Client	Disable ▼
Auto Reset (No data input)	2 (1 ~ 255 Minute)
Device Name	MATRIX-01

MAC address     OnLine

SceneMAC FilterAliasesBackApply

- **IP address** : Change **IP address**
- **Subnet mask** : Change **Subnet mask**
- **Gateway IP** : Change **Gateway IP**
- **Media Type** : Change **10 / 100 / Auto detect**
- **DHCP Client** : When setup at **Enable**, the MATRIX host will automatic get **IP Address** 、**Subnet Mask** 、**Gateway**, If setup at **Disable**, the **MATRIX** host **IP Address** 、**Subnet Mask** 、**Gateway** need to set from Advanced page.
- **Auto Reset** : The terminal connection people will be 4 users on line at same time, this function could setup the linking time to avoid long time linking and other user can not used. When over the setting link time, the terminal will automatically disconnect the link. . (0: no time setup, 1 ~ 255 Minute time range that can be setup)
- **Scene** : Click to enter **Scene** setup page
- **MAC Filter** : Enter to **MAC Filter to setup page**
- **Aliases** : Enter to **Aliases** to setup page
- **Device Name** : Can change device name
- **Back** : Jump back **SWITCH SETTING** page
- **Online** : Terminal connection users display, the max. 4 users on line.

**Aliases:**

**HDMI 2.0 10x10 MATRIX**

**Aliases**

Output		Input	
Output 1	<input type="text" value="Output 1"/>	Input 1	<input type="text" value="Input 1"/>
Output 2	<input type="text" value="Output 2"/>	Input 2	<input type="text" value="Input 2"/>
Output 3	<input type="text" value="Output 3"/>	Input 3	<input type="text" value="Input 3"/>
Output 4	<input type="text" value="Output 4"/>	Input 4	<input type="text" value="Input 4"/>
Output 5	<input type="text" value="Output 5"/>	Input 5	<input type="text" value="Input 5"/>
Output 6	<input type="text" value="Output 6"/>	Input 6	<input type="text" value="Input 6"/>
Output 7	<input type="text" value="Output 7"/>	Input 7	<input type="text" value="Input 7"/>
Output 8	<input type="text" value="Output 8"/>	Input 8	<input type="text" value="Input 8"/>
Output 9	<input type="text" value="Output 9"/>	Input 9	<input type="text" value="Input 9"/>
Output 10	<input type="text" value="Output 10"/>	Input 10	<input type="text" value="Input 10"/>

- **Aliases** page can change input/output name, enter **Apply** to finish the setting after change. **The new name will update and correspond to SWITCH SETTING page Output / Input.**
- Press **Back** jump back to **advanced** page.

**MAC Filter:**

**HDMI 2.0 10x10 MATRIX**

**MAC Filter**

<b>MAC Filter</b>	Enable <input type="button" value="v"/>
<b>MAC address 1</b>	<input type="text" value="11-22-33-44-55-66"/>
<b>MAC address 2</b>	<input type="text" value="00-00-00-00-00-00"/>
<b>MAC address 3</b>	<input type="text" value="00-00-00-00-00-00"/>
<b>MAC address 4</b>	<input type="text" value="00-00-00-00-00-00"/>
<b>MAC address 5</b>	<input type="text" value="00-00-00-00-00-00"/>
<b>MAC address 6</b>	<input type="text" value="00-00-00-00-00-00"/>
<b>MAC address 7</b>	<input type="text" value="00-00-00-00-00-00"/>
<b>MAC address 8</b>	<input type="text" value="00-00-00-00-00-00"/>
<b>MAC address 9</b>	<input type="text" value="00-00-00-00-00-00"/>
<b>MAC address 10</b>	<input type="text" value="00-00-00-00-00-00"/>

- **MAC Filter** can be setup as registered **MAC Address** to link **MATRIX host Web UI**, the max. up to 10 groups **MAC Address**
- After **MAC Address** fill in, select **Enable** and press **Apply** to complete the setting.
- Press **Back** jump to **advanced** page.

## Scene:

HDMI 2.0 10x10 MATRIX		
Scene		
Save	Load	1 2 3 4 5 6 7 8 9 10
Save1	Load1	01_02_03_04_05_06_07_08_09_10
Save2	Load2	01_02_03_04_05_06_07_08_09_10
Save3	Load3	01_02_03_04_05_06_07_08_09_10
Save4	Load4	01_02_03_04_05_06_07_08_09_10
Save5	Load5	01_02_03_04_05_06_07_08_09_10
Save6	Load6	01_02_03_04_05_06_07_08_09_10
Save7	Load7	01_02_03_04_05_06_07_08_09_10
Save8	Load8	01_02_03_04_05_06_07_08_09_10
Save9	Load9	01_02_03_04_05_06_07_08_09_10
Save10	Load10	01_02_03_04_05_06_07_08_09_10
Back	Update	

- **Save** : Save 10 set of channel settings
- **Load** : Reload 1 of the channel settings
- **Update**: Refresh the status of Load
- **Back** : Back to **Advanced** page

## 8. Android APP Function:

APP name: Matrix Controller



### System Requirement

Android 4.0 and up

Size: 1.2M

Language: English, Traditional Chinese, Simplified Chinese

### Google Play Download Link

<https://play.google.com/store/apps/details?id=sct.com.matrixcontroller>

### Google Play Download QR code



### System Setting

Connect mobile phone to Wi-Fi and set the IP/ subnet mask same with matrix network segment

Default IP address of matrix is **192.168.0.10**

Default subnet mask is 255.255.255.0

You could also set to DHCP mode, please refer user manual

There are two ways to get the IP address of matrix:

1. Use APP function: Scan Device to get the IP address.
2. Use panel button or IR remote control by press [MENU], select to [ETHERNET] function and press [ENTER] to enter [IP Address] function than press [ENTER], it will show IP Address in the LCD panel of matrix



## Main Page:



When first time enter the APP will see the main page

Bottom left 「+」 to add matrix

Bottom right 「Info」 to show information

## Scan Device

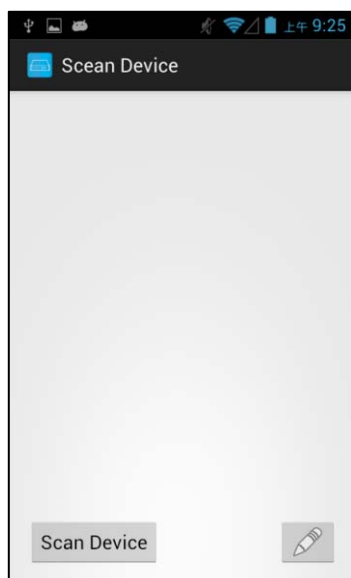

Touch 「+」 button at main screen to enter 「Scan Device」 page

Touch bottom left 「Scan Device」 to start scan

Touch bottom right pen icon to input the IP address manually

## Add Matrix

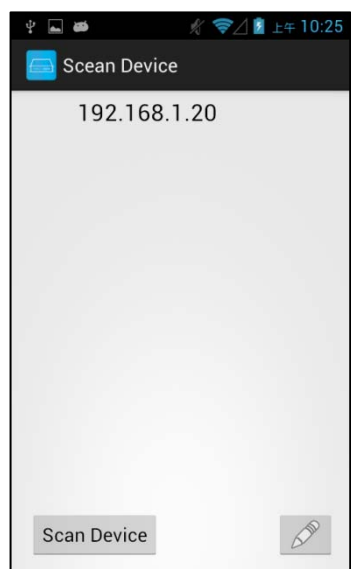

After scanning it will show all matrixes in the list

Touch the IP in list to enter 「Add Device」 page

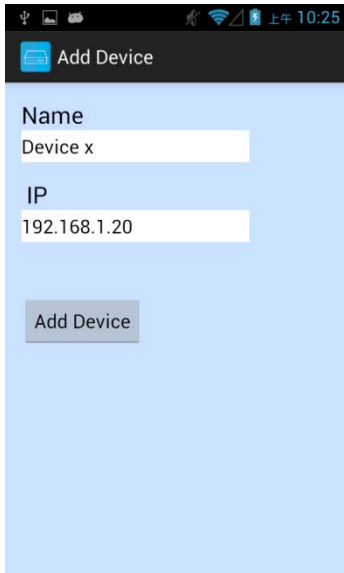

Enter the name of matrix then touch 「 Add Device 」 to finish setting  
**Notice : Name should be unique, not allow duplicate**

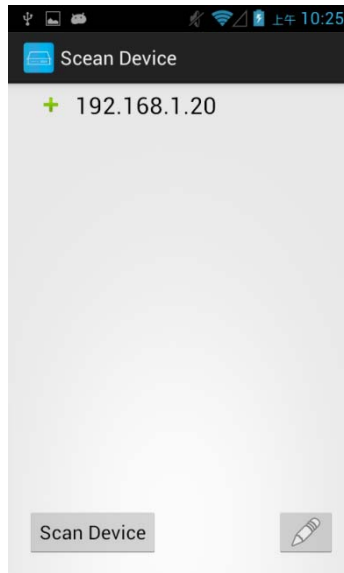

It will show 「 + 」 icon in front of the IP address when finished



Return to main screen you will see the matrix which just add

## Modify Device



Press the matrix name to show pop-up dialog

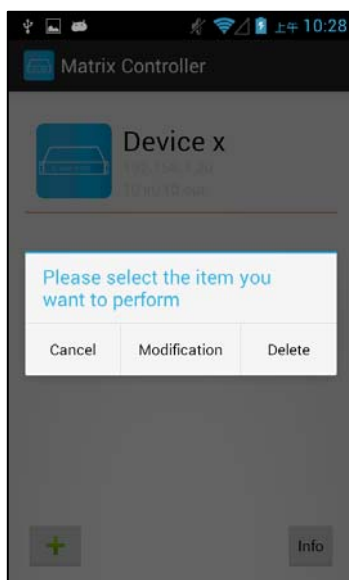

Touch 「Modification」 to enter modification page.

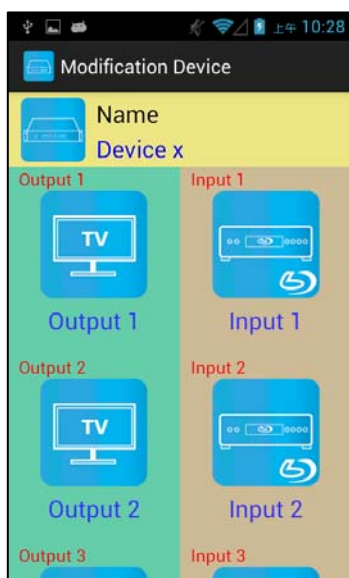

Yellow block shows matrix name and icon

Green block shows name and icon of output devices

Brown block shows name and icon of input devices

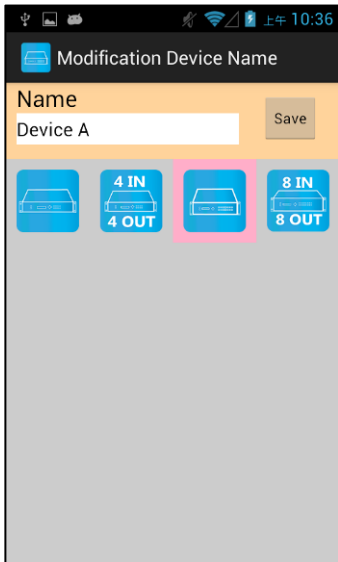

Touch yellow block to modify matrix name and icon

Input the name and select the icon you prefer then touch 「 Save 」 to finish

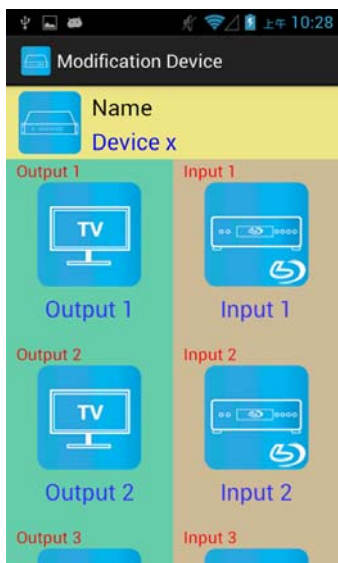

Return to Modification page you will see the matrix have been changed

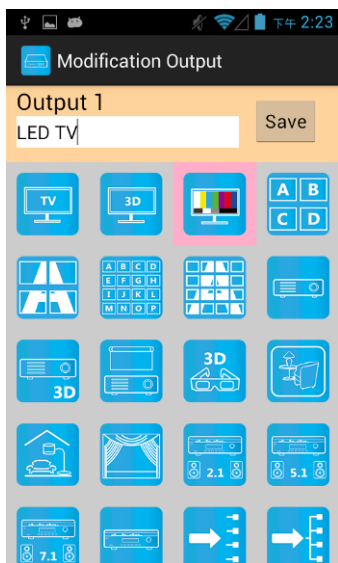

Touch green block to modify output name and icon

Input the name and select the icon you prefer then touch 「 Save 」 to finish

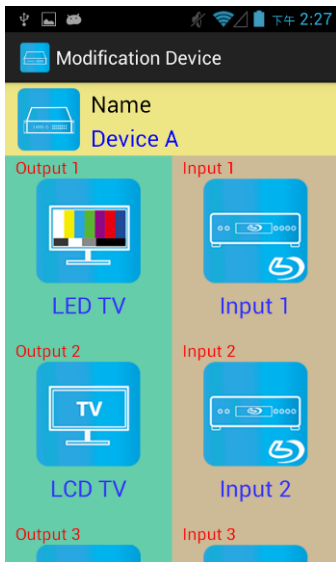

Return to Modification page you will see the output have been changed

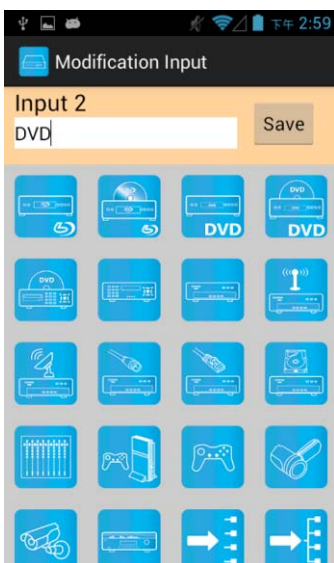

Touch brown block to modify input name and icon  
Input the name and select the icon you prefer then touch 「 Save 」 to finish

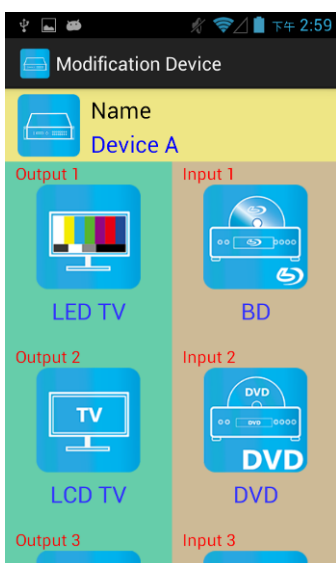

Return to Modification page you will see the input have been changed

## Channel Switching mode (load scene, input selection, output selection)

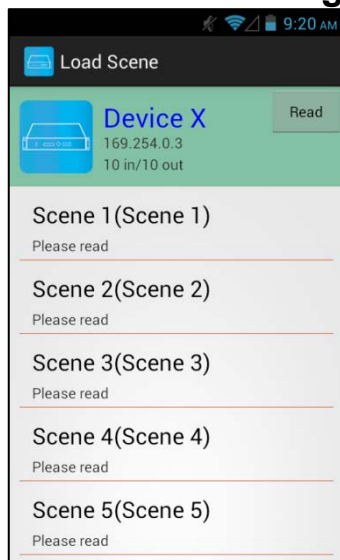

Click device name in list to enter load scene page



Slide right from load scene page to enter input selection mode (as before)



Slide left from load scene page to enter output selection mode (support multiple selection)

## Load scene Modify scene name

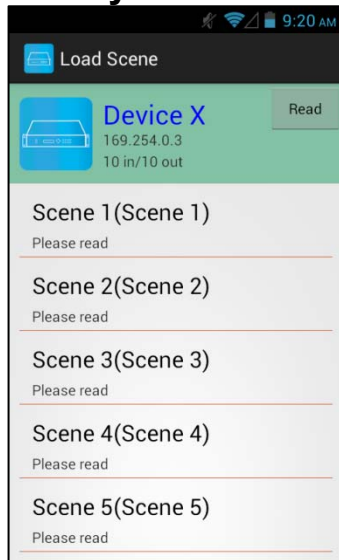

Press scene column to show pop-up dialog to modify scene name

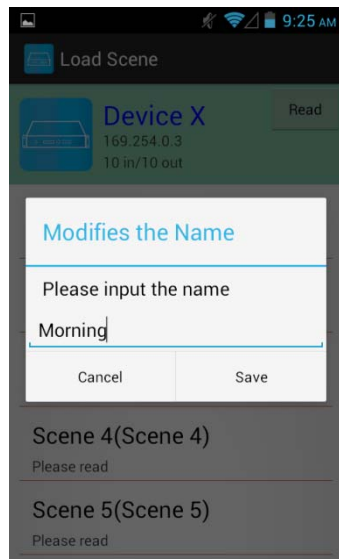

After modification touch 「 Save 」 to save scene name  
It will return to Load Scene page automatically.

**Notice : Name should be unique, not allow duplicate or empty**

## Read scene status

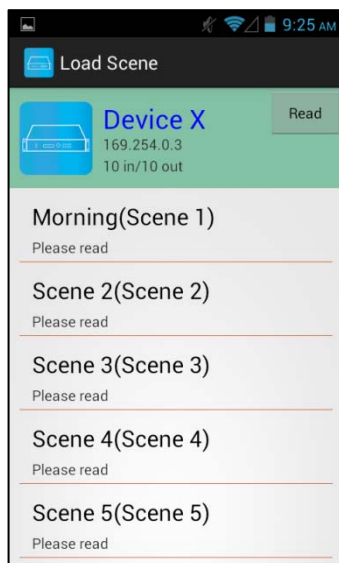

Touch top right 「 Read 」 to renew the scene status

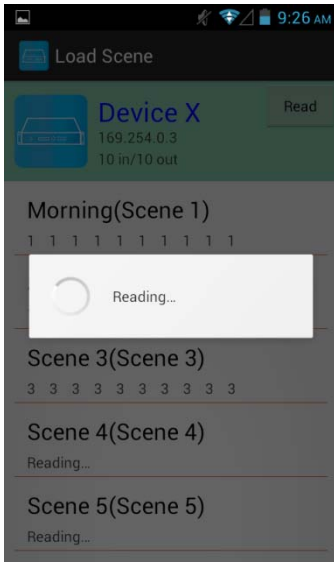

It will show pop-up message 「Reading...」  
After reading it will refresh scene status

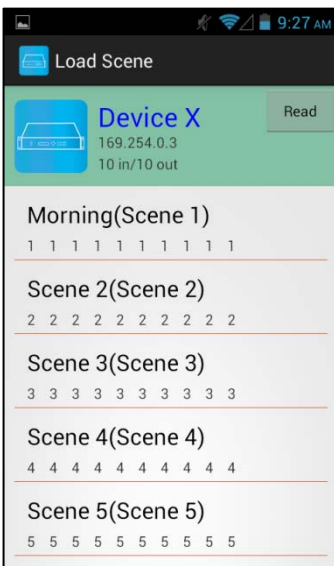

Touch the column name to show pop-up dialog

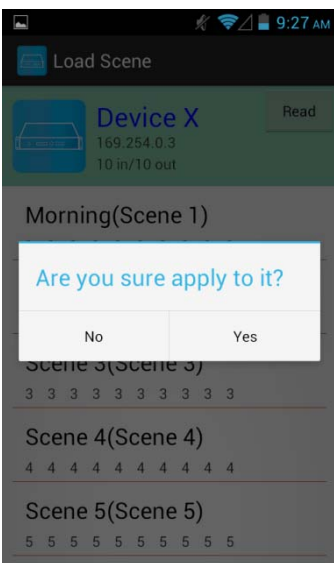

Touch 「Yes」 to apply scene



# Input Selection Mode



Top right 「 Refresh 」 to renew the status of matrix

Below 「 Refresh 」 button to power on/off the matrix

The block under device are Output 1~ Output 10  
(4 by 4 matrix only shows Output 1~Output 4)

Left side shows output device name

Right sideshows current input device name

Bottom left 「 Save Scene 」 to save the scenes



Touch output block to enter Channel Selection page

Touch input device to switch or ON/OFF icon to power on/off



It will return to Input Selection page after switching and you will see the input have been changed

## Output Selection Mode



Top right 「Refresh」 to renew the status of matrix

Below 「Refresh」 button to power on/off the matrix

The blocks under device are Input 1~ Input 10

(4 by 4 matrix only shows Input 1~Input 4)

Left side shows input device name

Right side shows current output numbers of devices

Bottom left 「Save Scene」 to save the scenes

Bottom right 「Video off」 to turn off video output

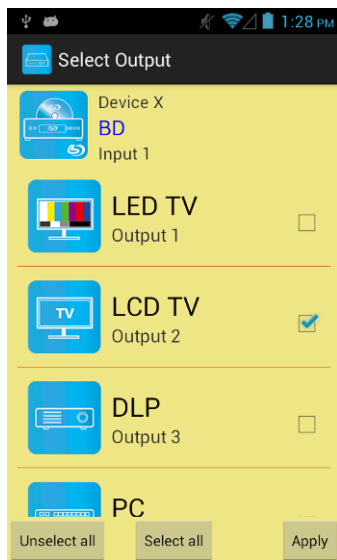

Touch input block or 「Video off」 to enter Output Selection page

It will show connected output of current input

Bottom left 「Unselect all」 to clear all output box

Bottom center 「Select all」 to check all output box

Bottom right 「Apply」 to apply output setting

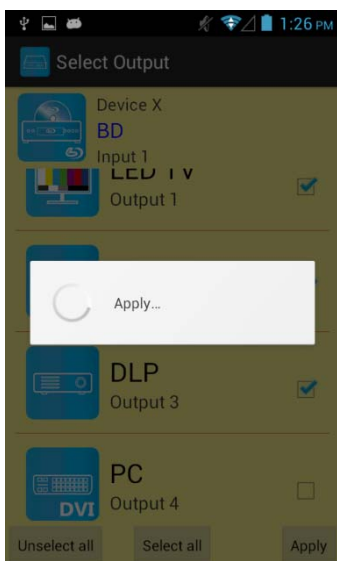

After touch 「Apply」 it will show pop-up message 「Apply...」

It will return to Input Selection page after switching and you will see the numbers of output have been changed

## Save Scene

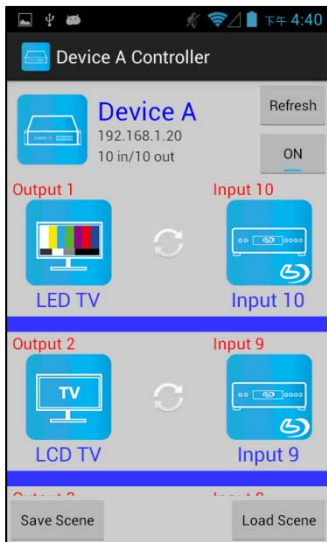

In Input or Output Selection page touch bottom left 「 Save Scene 」 to enter Save Scene page

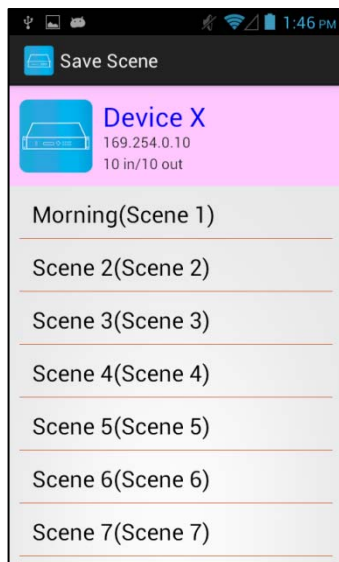

Touch the Scene column to show pop-up dialog

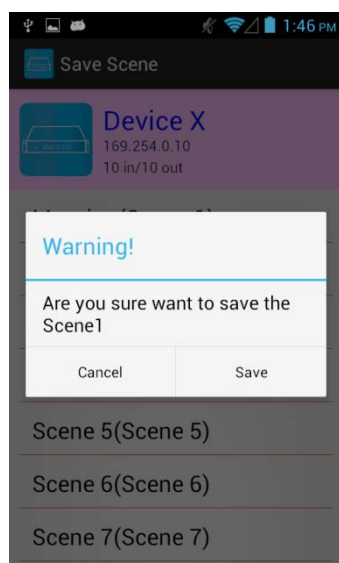

Touch 「 Save 」 to save current channels setting for all output  
It will return to Save Scene page automatically.

## Delete Matrix

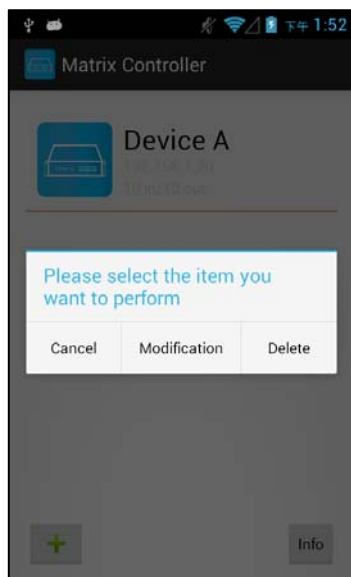

Press the block of matrix in Controller page to show pop-up dialog then touch 「Delete」

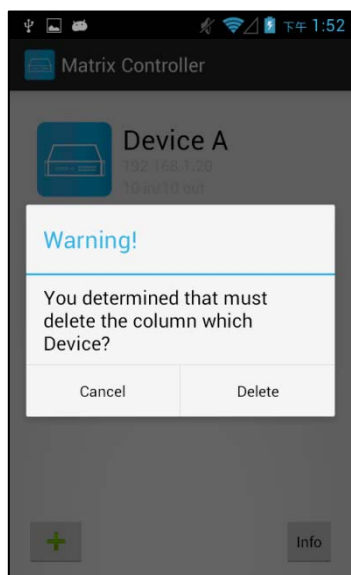

Touch 「Delete」 to delete the matrix

## 9. iOS APP Function:

APP name: Matrix Controller



### System Requirement

iOS 7.1 and up

Size: 2.3M

Language: English, Traditional Chinese, Simplified Chinese

### iTunes Download Link

<https://itunes.apple.com/us/app/matrix-control/id904487754?l=zh&ls=1&mt=8>

### iTunes Download QR code



### System Setting

Connect mobile phone to Wi-Fi and set the IP/ subnet mask same with matrix network segment

Default IP address of 10 by 10 matrix is 192.168.0.10

Default IP address of 4 by 4 matrix is 192.168.0.200

Default subnet mask is 255.255.255.0

You could also set to DHCP mode, please refer user manual

There are two ways to get the IP address of matrix:

1. Use APP function: Scan Device to get the IP address.
2. Use panel button or IR remote control by press [MENU], select to [ETHERNET] function and press [ENTER] to enter [IP Address] function than press [ENTER], it will show IP Address in the LCD panel of matrix

## Main Page:



When first time enter the APP will see the main page

Bottom left 「+」 to add matrix

Bottom right 「Info」 to show information

## Scan Device



Touch 「+」 button at main screen to enter 「Scan Device」 page

Touch bottom left 「Scan Device」 to start scan

Touch bottom right pen icon to input the IP address manually

## Add Matrix

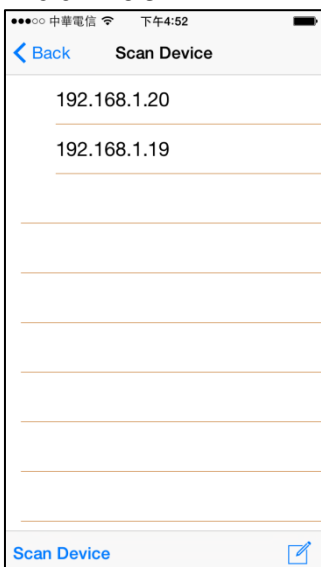

After scanning it will show all matrixes in the list

Touch the IP in list to enter 「Add Device」 page

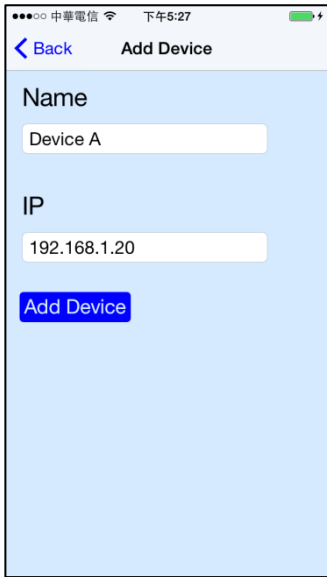

Enter the name of matrix then touch 「Add Device」 to finish setting  
**Notice : Name should be unique, not allow duplicate**

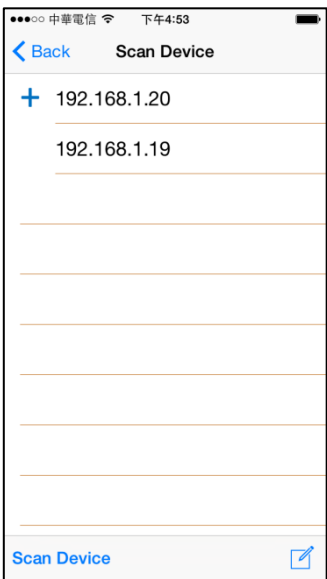

It will show 「+」 icon in front of the IP address when finished

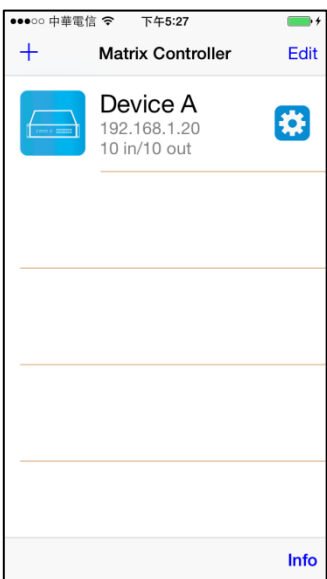

Return to main screen you will see the matrix which just add

# Modify Device

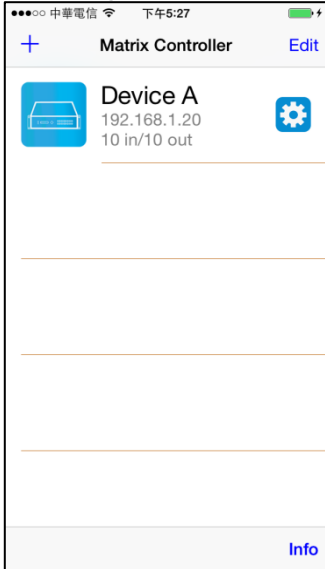

Touch the gear icon to enter Modification page

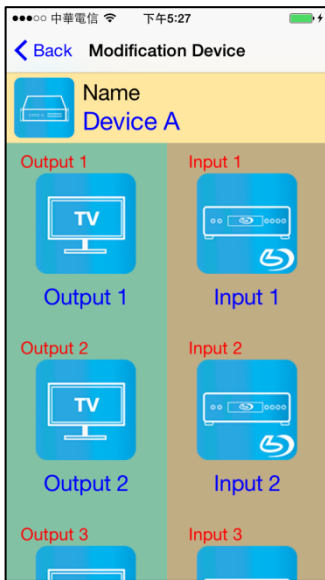

Yellow block shows matrix name and icon

Green block shows name and icon of output devices

Brown block shows name and icon of input devices

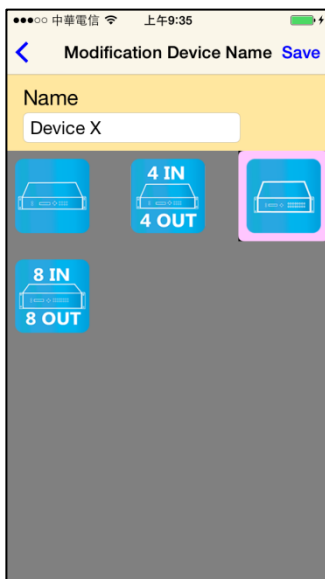

Touch yellow block to modify matrix name and icon

Input the name and select the icon you prefer then touch 「 Save 」 to finish



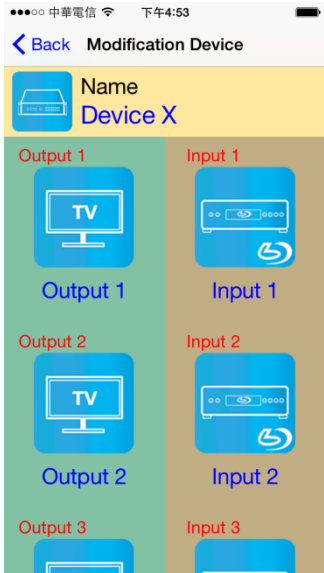

Return to Modification page you will see the matrix have been changed



Touch green block to modify output name and icon  
 Input the name and select the icon you prefer then touch 「 Save 」 to finish

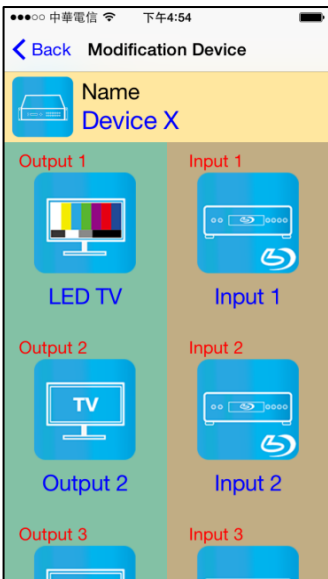

Return to Modification page you will see the output have been changed



Touch brown block to modify input name and icon  
Input the name and select the icon you prefer then touch 「 Save 」 to finish

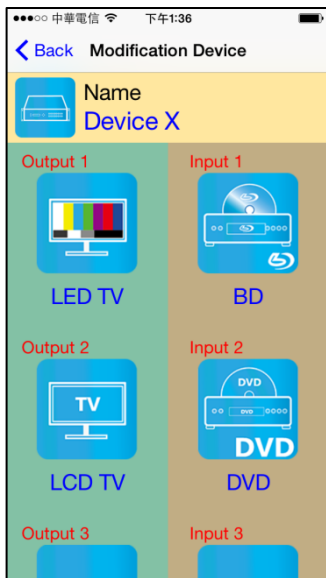

Return to Modification page you will see the input have been changed

## Channel Switching mode (load scene, input selection, output selection)

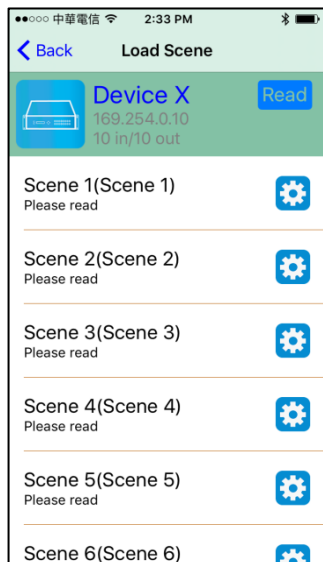

Click device name in list to enter load scene page

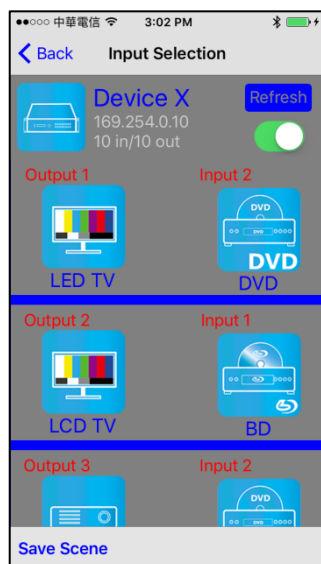

Slide right from load scene page to enter input selection mode (as before)

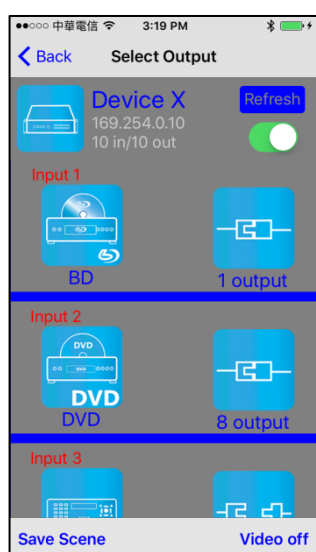

Slide left from load scene page to enter output selection mode (support multiple selection)

## Load scene Modify scene name

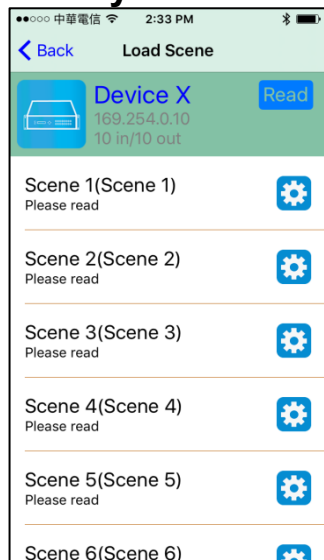

Touch the gear icon to enter modify scene name

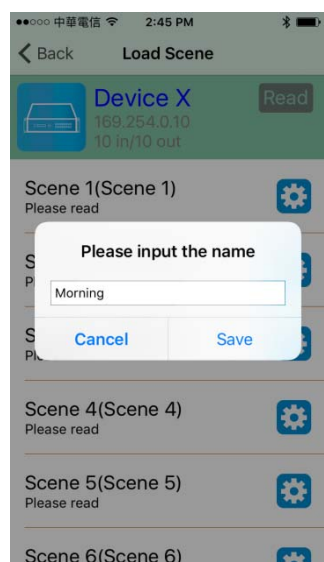

After modification touch 「 Save 」 to save scene name  
It will return to Load Scene page automatically.

**Notice : Name should be unique, not allow duplicate or empty**

## Read scene status

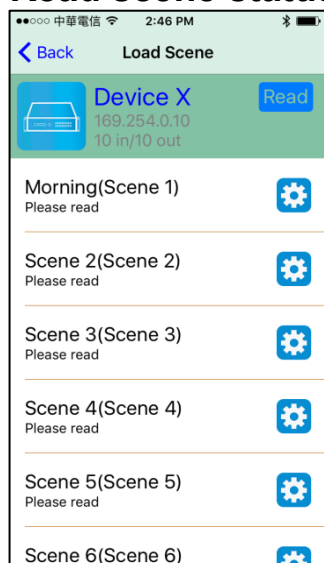

Touch top right 「 Read 」 to renew the scene status

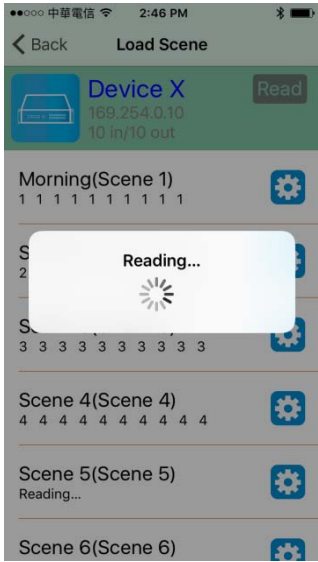

It will show pop-up message 「Reading...」  
After reading it will refresh scene status

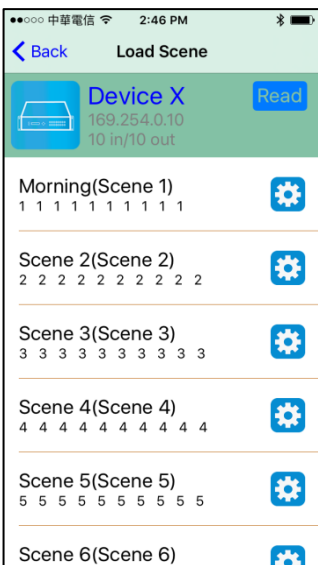

Touch the column name to show pop-up dialog

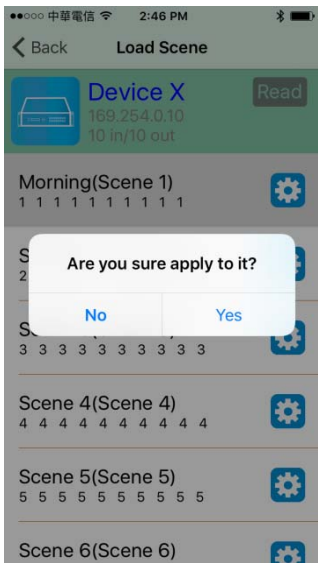

Touch 「Yes」 to apply scene

# Input Selection Mode



Top right 「 Refresh 」 to renew the status of matrix  
Below 「 Refresh 」 button to power on/off the matrix

The block under device are Output 1~ Output 10  
(4 by 4 matrix only shows Output 1~Output 4)  
Left side shows output device name  
Right side shows current input device name

Bottom left 「 Save Scene 」 to save the scenes



Touch output block to enter Channel Selection page

Touch input device to switch or ON/OFF icon to power on/off

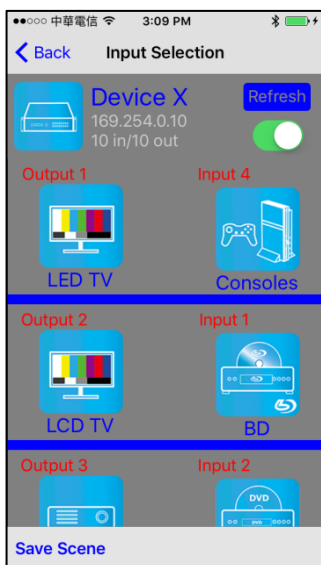

It will return to Input Selection page after switching and you will see the input have been changed

# Output Selection Mode

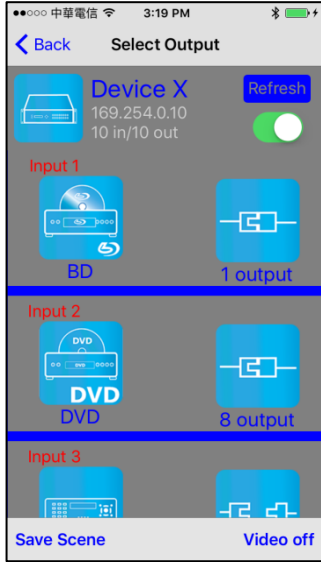

Top right 「Refresh」 to renew the status of matrix  
 Below 「Refresh」 button to power on/off the matrix

The blocks under device are Input 1~ Input 10  
 (4 by 4 matrix only shows Input 1~Input 4)  
 Left side shows input device name  
 Right side shows current output numbers of devices

Bottom left 「Save Scene」 to save the scenes  
 Bottom right 「Video off」 to turn off video output

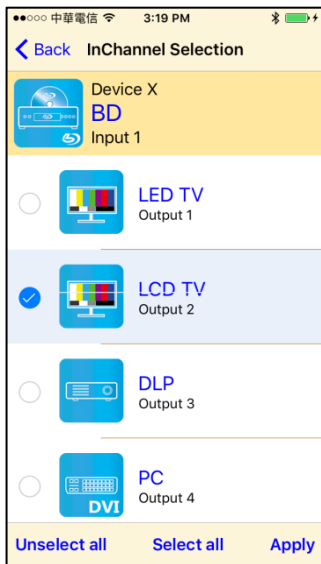

Touch input block or 「Video off」 to enter Output Selection page  
 It will show connected output of current input

Bottom left 「Unselect all」 to clear all output box  
 Bottom center 「Select all」 to check all output box  
 Bottom right 「Apply」 to apply output setting



After touch 「Apply」 it will show pop-up message 「Apply...」

It will return to Input Selection page after switching and you will see the numbers of output have been changed

# Save Scene

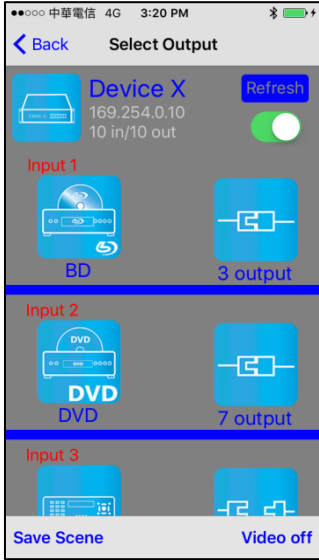

In Input or Output Selection page touch bottom left 「 Save Scene 」 to enter Save Scene page

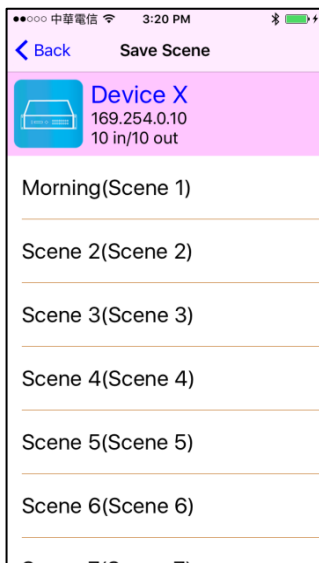

Touch the Scene column to show pop-up dialog

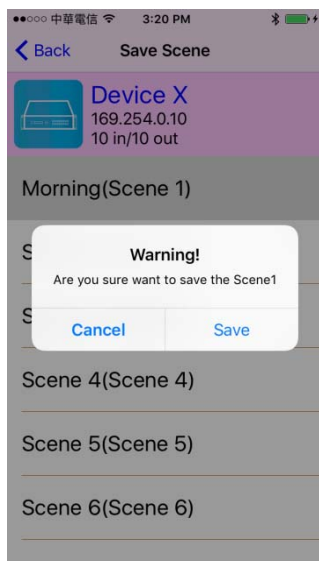

Touch 「 Save 」 to save current channels setting for all output  
It will return to Save Scene page automatically.



## Delete Matrix

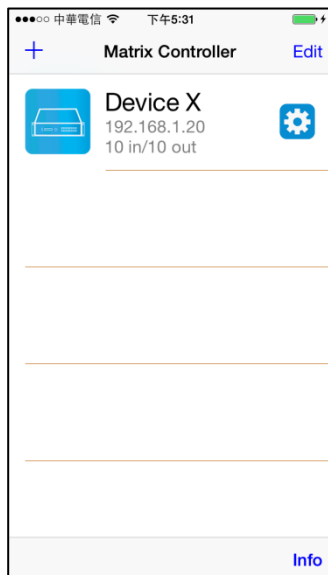

Touch top right 「Edit」 button to enter delete mode

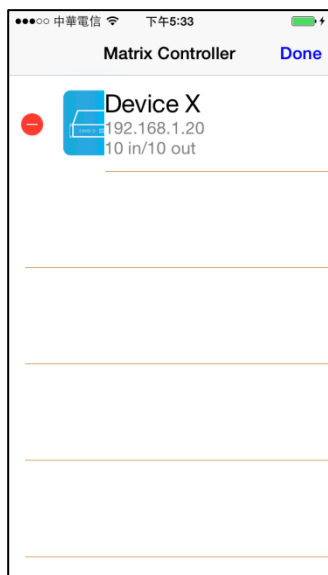

Touch 「-」 button in the left of matrix

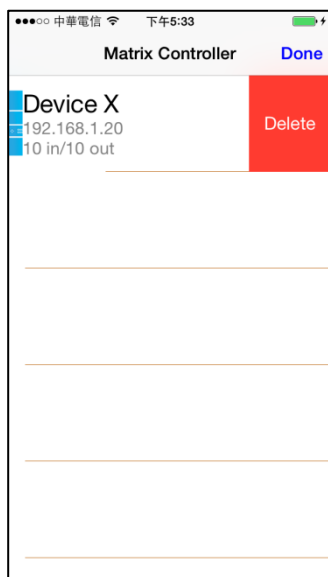

Touch 「Delete」 to delete the matrix

Touch top right 「Done」 to exit

## Specification:

<b>ITEM NO</b>	<b>HS10M-4K6G</b>
HDMI Resolution support	4K@60Hz 4:4:4 18Gbps (6Gbps per color) 、 1080p@60Hz 16bit 、3D 、HDR 、Dolby vision
Audio format support	LPCM 7.1 @ 192KHz 、Dolby TrueHD 、 ATMOS 、DTS-HD MA 、DTS:X
Video Input Interface	HDMI Type A x 10
Video Output Interface	HDMI Type A x 10
Audio Output Interface	RCA x 2
IR Output Interface	3.5mm Phone Jack x 1
Ethernet Interface	RJ45 x 1
RS-232 Input/Output Interface	DB9 x 1(CONSOLE)
IR Receive Angle	± 45 degree
IR Receive Distance	5M
Power Adapter	DC 12V 6.67A
Power Consumption	2.8A
Temperature	Operation: 0 to 55°C , Storage: -20 to 85°C , Humidity: up to 95%
Dimension                      mm	483 x 232 x 44
Weight                              g	2920

RoHS   

HW Rev.: A1 / FW Rev.: 1.01 / Date: 200110