

HDMI Matrix Switcher Series

ITEM NO.: HS04M 4 x 4 HDMI Matrix Switcher

HS04M 4x4 HDMI Matrix Switch allows you to route 4 HD sources to any 4 HD displays! The **4x4 HDMI Matrix switch** is a complete HD routing solution for whole home HDTV systems. It provides **3D support**, **Full 1080P**, and is **1 RU Rack** mountable for professional installations. In addition, the **HS04M** allows for effortless control of up to 4 devices through Ethernet control, Android App Control, IR remote control, RS-232 and the front panel.



Features:

- Connect up to 4 HDMI source to 4 x HDMI display monitors.
- HDMI 1.4 with 3D, HDCP & DVI Compliant.
- High definition video up to 1080p@60Hz@12bits.
- Easy to use front panel control of switching or using the included remote control.
- [Built in Ethernet Control and Android App Control.](#)
- Built in RS232 console port to select input/output.
- Input/Output status could be displayed at front panel LCM & LED.

● **Optional Model:**

RC04: 4 x 4 Keypad remote control (select HE04M input/output)



1.0 HS04M Panel View:

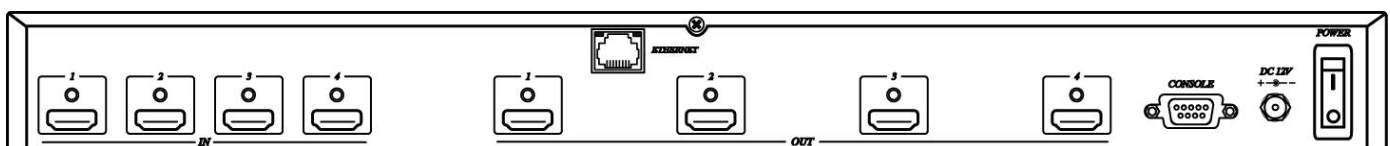
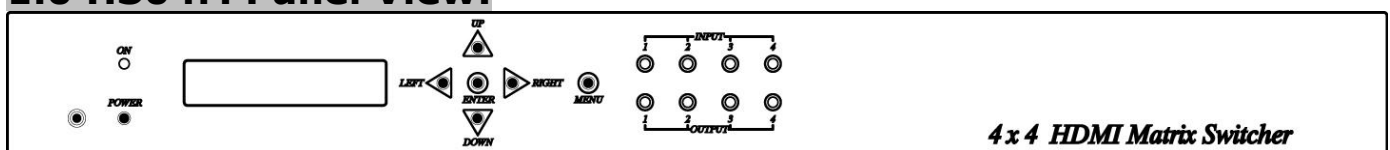

2.0 HS04M Connection View:

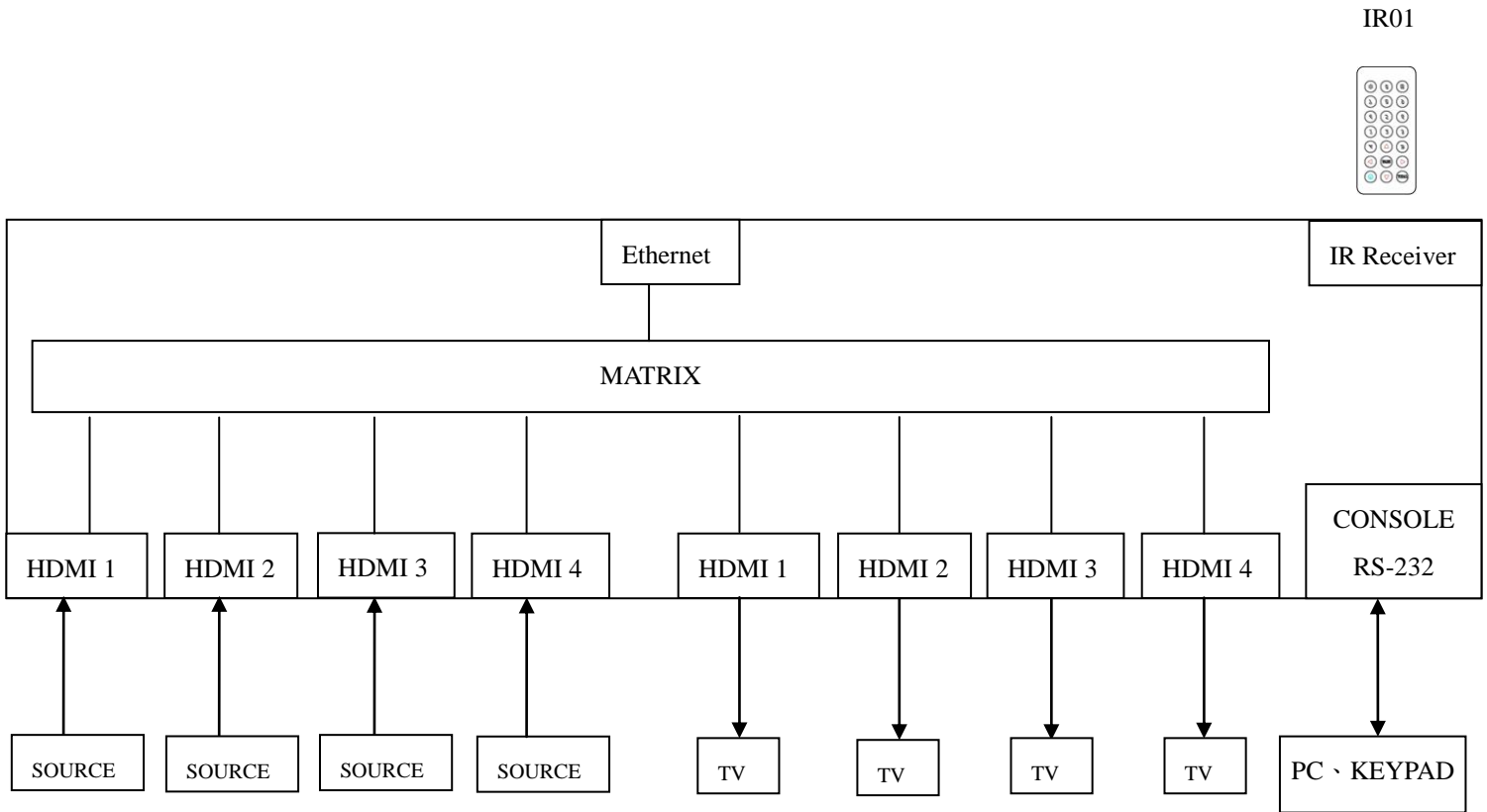

3.0 Keypad and Leds

3.1 Back Panel Switch:

POWER	Light on	Power on
	Light off	Power off

3.2 Front LED Indication:

ON	BLUE	Power on
	RED	Standby
	LED off	Power Off
INPUT 1, 2, 3, 4	BLUE	Presence signal indication
	LED off	No signal incoming
OUTPUT 1, 2, 3, 4	BLUE	HDMI output indications
	LED off	Output unlink

3.3 Standby mode: The IR Remote only could control POWER on/off.

Front Button Function:

Power	Power on/standby
UP	up
DOWN	down
LEFT	left
RIGHT	right
ENTER	select confirm key
MENU	back to main menu

*When the sub-menu setting changed, press the ENTER key to complete the setting. If no press ENTER key, then the setting will be failed.

3.4 LCM Panel Function:

4X4 HDMI MATRIX: Power on Main Screen

When the power is on and the main screen appears, press the MENU key to enter the main menu

Main MENU Option:

*** SWITCH SETTING**

MATRIX IR ID

ETHERNET

EDID

FIRMWARE VER.

KEYLOCK

Operation:

- Press UP or DOWN key to move * to select an item for setting and press ENTER key to enter into subpage.
- When the selected sub-page setting is completed, press the MENU button to return to the main page

4.0 LCM Main MENU Function Operations:

4.1 SWITCH SETTING : (Default: 1 2 3 4)

OUTPUT	1	2	3	4
INPUT	1	2	3	4

This function is used to switch the input/output port. Enter the SWITCH SETTING menu. Press the ENTER key, then the LCM second line INPUT will flash. Press LEFT or RIGHT button to select the output to be modified. Then press UP or Down button to select the input port. After that, press ENTER to confirm setting.

OUTPUT	1	2	3	4
INPUT	1	2	3	4

4.2 MATRIX IR ID : (Default IR ID: 4)

MATRIX IR ID	4
--------------	---

This function must be set to match the Matrix remote control IR01 with the matrix itself. A conflict with other devices remote control is avoided.

After entering MATRIX IR ID menu, press ENTER, the LCM LINE 1 number will flash. Then Press UP or DOWN button to select the number, and then press ENTER to confirm.

When finish MATRIX IR ID setting, MATRIX remote control IR01 must also set the same ID in order to operation in normal.

Remote IR ID setting mode: Press and hold the POWER button, then press the number button which can be set from 0 to 9, total 10 groups. (See 5.1)

These settings on IR01 remote control have to be done the first time you use the IR01 or when you change the batteries.

MATRIX IR ID	4
--------------	---



+

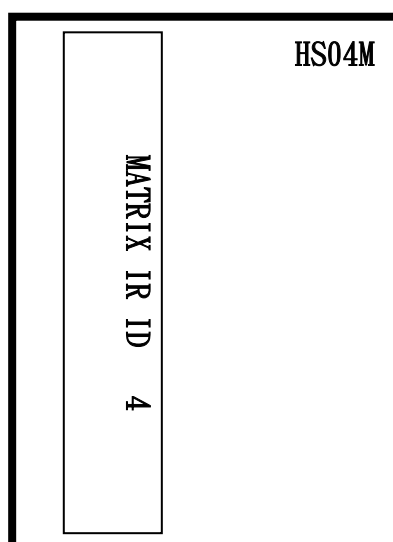

4.3 Ethernet

- * IP Address
- Subnet Mask
- Gateway
- DHCP Client
- Media Type
- MAC Filter

IP Address: (Default: 192.168.0.200)

IP Address 192.168. 0.200

This function can be setup MATRIX host intranet "IP Address", press the ENTER, the left-most number of second row will flash, then press the UP or DOWN button to change the numbers, , press LEFT or RIGHT to move to another location, the move to a position number will flash, press ENTER to complete the setting.

Subnet Mask: (Default 255.255.255.0)

Subnet Mask 255. 255. 255. 000

This function can be setup MATRIX host intranet "Subnet Mask", press the ENTER, the left-most number of second row will flash, then press the UP or DOWN button to change the numbers Press the ENTER, , press LEFT or RIGHT to move to another location, the move to a position number will flash, press ENTER to complete the setting.

Gateway: (Default 192.168.0.1)

Gateway 192.168. 0. 1

This function can be setup MATRIX host intranet "Gateway", press the ENTER, the left-most number of second row will flash, then press the UP or DOWN button to change the numbers Press the ENTER, , press LEFT or RIGHT to move to another location, the move to a position number will flash, press ENTER to complete the setting.

DHCP Client: (Default Disable)

DHCP Client Disable

When DHCP Clients setup at “Enable”, the MATRIX host will automatically get IP Address, Subnet Mask, Gateway, if setup at “Disable”, the MATRIX Host IP Address need go through “ ETHERNET” menu to set IP Address, Subnet Mask, Gateway, to press the ENTER, the second row will flash, then press the UP or DOWN to select DISABLE, ENABLE, then press ENTER to complete the setting.

Media Type: (Default 100M)

Media Type 100M

This function can be setup MATRIX host intranet “Media Type, press the ENTER, the second row will flash, then press the UP or DOWN button to select 10M, 100M, AUTO, press ENTER to complete the setting.

MAC Filter : (Default Disable)

MAC Filter can be setup with registered MAC Address in order to connect the MATRIX host Web UI, MAC Address required by the Web page to fill in, this function can only be setup at “DISABLE”, “ENABLE”, then to press the ENTER, the second row will flash, then press the UP or DOWN to select DISABLE, ENABLE, then press ENTER to complete the setting.

4.4 EDID: (Default: LPCM-2CH)

Because the player output display resolution will be based on TV EDID, this Matrix provides two default EDID modes: "BUILD-IN MODE" and "COPY MODE".

BUILD-IN MODE
COPY MODE

4.4.1 BUILD-IN MODE :

This mode supports video resolution 480p, 720p, 1080i / p at 24/50/60Hz, support LPCM two-channel audio and 5.1 channel. After enter BUILD-IN MODE menu, press UP or DOWN key to select LPCM-2CH or LPCM-5.1CH, then press ENTER to confirm setting.

LPCM-2CH
LPCM-5.1CH

BUILD-IN MODE
COPY MODE

BUILD-IN MODE :

This mode supports video resolution 480p, 720p, 1080i / p at 24/50/60Hz, support LPCM two-channel audio and 5.1 channel. After enter BUILD-IN MODE menu, press UP or DOWN key to select LPCM-2CH or LPCM-5.1CH, then press ENTER to confirm setting.

LPCM-2CH
LPCM-5.1CH

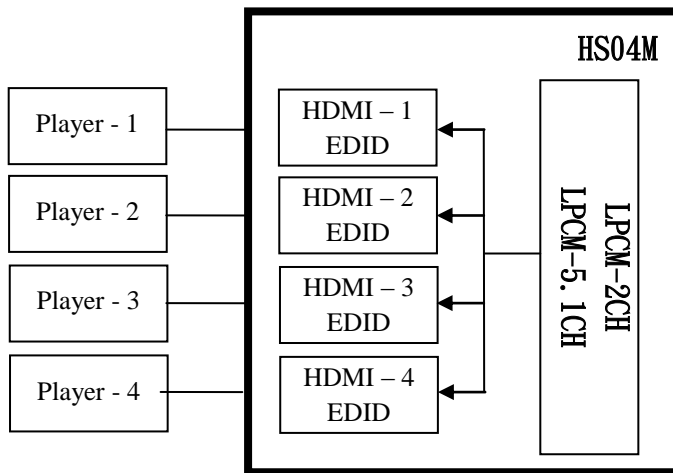

COPY MODE :

To fully support the TV resolution and audio mode, the matrix provides "copy mode" to copy TV EDID for input source reference. When use the copy mode, recommend copying the lowest resolution TV EDID. Otherwise it may cause no picture display if the TV resolution is not able to support higher resolution.

After entering COPY MODE menu, press UP or DOWN button to select the OUTPUT (1 to 4). Then press ENTER. Press UP or DOWN button to select the INPUT (1 to 4). Then press ENTER to confirm.

From OUTPUT: 1
To INPUT: 1

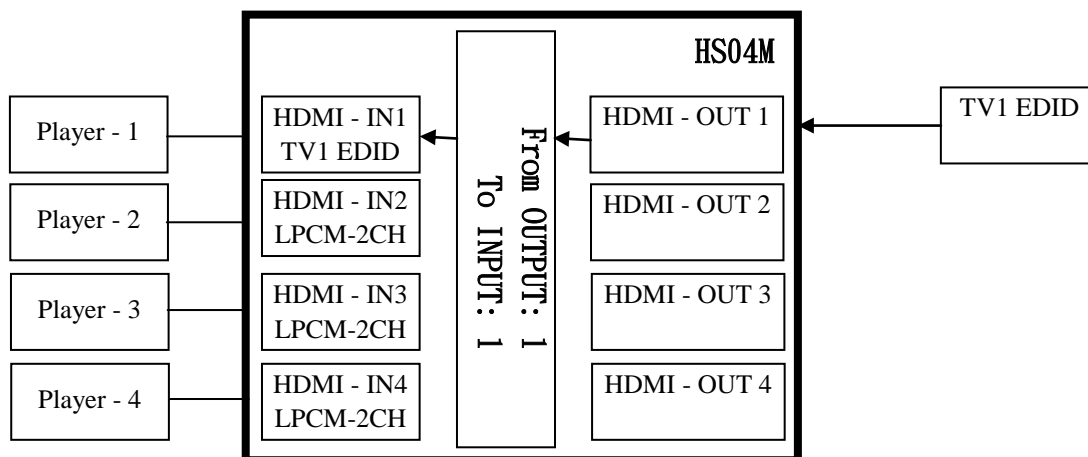

4.5 FIRMWARE VER.:

Display HS04M Matrix firmware version

4.6 KEYLOCK:

KEYLOCK function is to avoid any wrong button press. Under key lock mode press "POWER + MENU" to unlock

5.0 Remote Control Function (IR01):



5.1 To command the matrix locally, setup the remote control IR01 ID with the same code of the Matrix (see 4.2). The default code is 4. (Power+4)

5.2 Warning: These settings have to be done the first time you use the IR01 or when you change the batteries.

- IR ID setup : press and hold POWER button , then press Number key

Remote control button define:

Symbol



Power



LEFT



RIGHT



UP



DOWN



ENTER



MENU



1



2



3



4



5

Function Side

ON/Standby (same as Matrix)

left (same as Matrix)

right (same as Matrix)

up (same as Matrix)

down (same as Matrix)

confirm (same as Matrix)

menu (same as Matrix)

Quick key1

Quick key2

Quick key3

Quick key4

No function



No function



No function



No function



No function



Turn off output

For example: to connect output port 1 to input port 4, press the quick key 1 (OUTPUT 1) and then press the quick key 4 (INPUT 4).

* Under using quick key operation, LCM screen will jump to the output / input setting page; it won't allow using the front panel button to operate the HE04M Matrix.

6.0 RS232 Computer Local Control Function : (CONSOLE)

CONSOLE



6.1 Connect the RS232 CONSOLE port to the COM port of the host by an F/M RS232 straight cable (pin 2 to pin 2; pin 3 to pin 3, pin 5 to pin 5).

The Matrix communication format is 9600, 8, N, 1 (9600 bps, 8 data bits, no parity check, 1 stop bit)

6.2 Operation Instruction format:

Command + Space + parameter + Enter

The Matrix will reply **OK** once string is correct, **NG** in case of incorrect string

TX[x] SP [y] is the string to switch on output x the input y

PWR SP [z] is the string to put the matrix in Standby and On status

[SYMBOL]

[PARAMETER]

x	1 2 3 4	Output 1 to 4
y	01 02 03 04 00	Input 1 to 4, 00: Off
z	00 01	00: Standby, 01: On

Example:

-To route input 4 to output 1, send the following string:

Command Input
TX1 SP 04 Enter

-To route input 2 to output 3, send the following string:

Command Input
TX3 SP 02 Enter

-To put in standby the matrix, send the following string:

Command
PWR SP 00 Enter

Command are **case insensitive**. Be sure that your terminal after Enter (0D Hex) character doesn't send LF (0A). In this case, command will not be executed.

7. Ethernet Control Function:

Initial IP Configuration

1. Setup MATRIX IP Address same as your PC with same domains.(Default 192.168.0.200)
MATRIX IP Address method, please refer. to “ETHERNET” Chapter
2. Input IP Address on a web page, you could link to the Web UI of the MATRIX host.
3. Web UI Operation :

SWITCH SETTING:

The screenshot shows the 'MATRIX SWITCH SETTING' web interface. At the top, there is a green header with the word 'MATRIX' in white. Below the header, the title 'SWITCH SETTING' is displayed in orange. The interface is divided into three main sections: 'Power', 'Output', and 'Input'. The 'Power' section has a dropdown menu currently set to 'Power On'. The 'Output' section has four text input fields labeled 'Output 1' through 'Output 4'. The 'Input' section has four dropdown menus labeled 'Input 1' through 'Input 4'. To the right of these sections, there are two purple buttons: 'Reload' and 'Advanced'. At the bottom right, there is an 'Apply' button. At the top center, there is a text input field containing 'RS232_TCPIP'.

- **Power** : Control MATRIX power on and standby.
- **Output** : Display output 1~4, it can change the display name by the Aliases page.
- **Input** : Display input 1~4, this field is a drop down menu, this field is a drop-down menu, a drop-down menu include Input 1 ~ 4 and OFF, It can change the display name by the Aliases page.
- **Reload** : Get MATRIX host message.
- **Advanced** : Enter into the “Advanced” page.
- **Apply** : Complete the setting

Advanced:

MATRIX

Advanced

IP address	192.168.0.200
Subnet mask	255.255.255.0
Gateway IP	0.0.0.0
Media Type	Auto detect
DHCP Client	Disable
Auto Reset (No data input)	0 (1 ~ 255 Minute)
Device Name	RS232_TCPIP

MAC address OnLine

MAC Filter Aliases Back Apply

- **IP address** : Change **IP address**
- **Subnet mask** : Change **Subnet mask**
- **Gateway IP** : Change **Gateway IP**
- **Media Type** : Change **10 / 100 / Auto detect**
- **DHCP Client** : When setup at **Enable**, the MATRIX host will automatic get **IP Address** 、**Subnet Mask** 、**Gateway**, If setup at **Disable**, the **MATRIX** host **IP Address** 、**Subnet Mask** 、**Gateway** need to set from Advanced page.
- **Auto Reset** : The terminal connection people will be 4 users on line at same time, this function could setup the linking time to avoid long time linking and other user can not used. When over the setting link time, the terminal will automatically disconnect the link. . (0: no time setup, 1 ~ 255 Minute time range that can be setup)
- **MAC Filter** : Enter to **MAC Filter to setup page**
- **Aliases** : Enter to **Aliases** to setup page
- **Device Name** : Can change device name
- **Back** : Jump back **SWITCH SETTING** page
- **Online** : Terminal connection users display, the max. 4 users on line.

Aliases:

Output		Input	
Output 1	<input type="text" value="Output 1"/>	Input 1	<input type="text" value="Input 1"/>
Output 2	<input type="text" value="Output 2"/>	Input 2	<input type="text" value="Input 2"/>
Output 3	<input type="text" value="Output 3"/>	Input 3	<input type="text" value="Input 3"/>
Output 4	<input type="text" value="Output 4"/>	Input 4	<input type="text" value="Input 4"/>

- **Aliases** page can change input/output name, enter **Apply** to finish the setting after change
The new name will update and correspond to **SWITCH SETTING** page **Output / Input**.
- Press **Back** jump back to **advanced** page.

MAC Filter:

MAC Filter	Enable
MAC address 1	<input type="text" value="11-22-33-44-55-66"/>
MAC address 2	<input type="text" value="00-00-00-00-00-00"/>
MAC address 3	<input type="text" value="00-00-00-00-00-00"/>
MAC address 4	<input type="text" value="00-00-00-00-00-00"/>
MAC address 5	<input type="text" value="00-00-00-00-00-00"/>
MAC address 6	<input type="text" value="00-00-00-00-00-00"/>
MAC address 7	<input type="text" value="00-00-00-00-00-00"/>
MAC address 8	<input type="text" value="00-00-00-00-00-00"/>
MAC address 9	<input type="text" value="00-00-00-00-00-00"/>
MAC address 10	<input type="text" value="00-00-00-00-00-00"/>

- **MAC Filter** can be setup as registered **MAC Address** to link **MATRIX** host **Web UI**, the max. up to 10 groups **MAC Address**
- After **MAC Address** fill in, select **Enable** and press **Apply** to complete the setting.
- Press **Back** jump to **advanced** page.

Android APP Function:

Main Page:

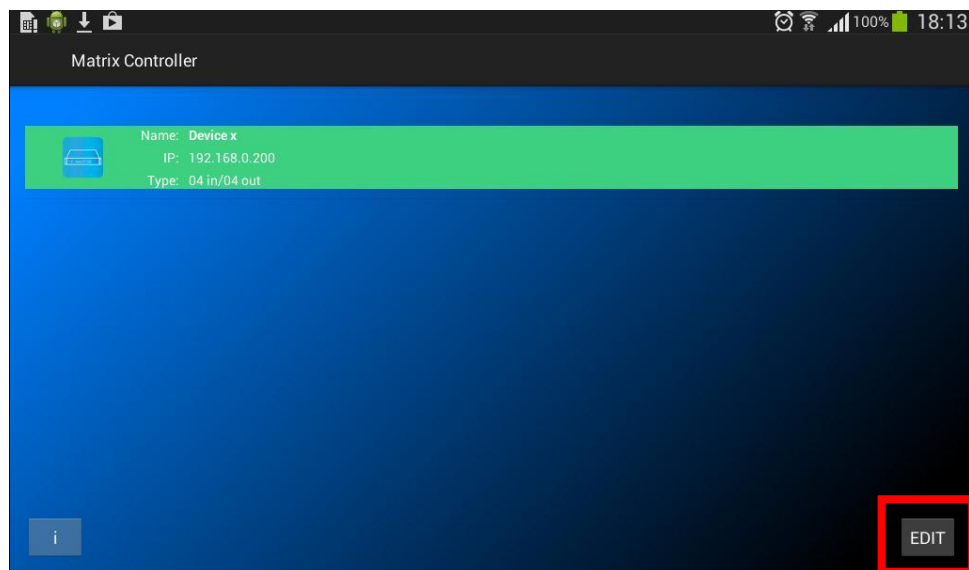

- Middle Column: **MATRIX host information**
- **I**: **Version information**
- **Edit**: **Edit button** (red box), enter to check the **Edit page description**.

EDIT Page:

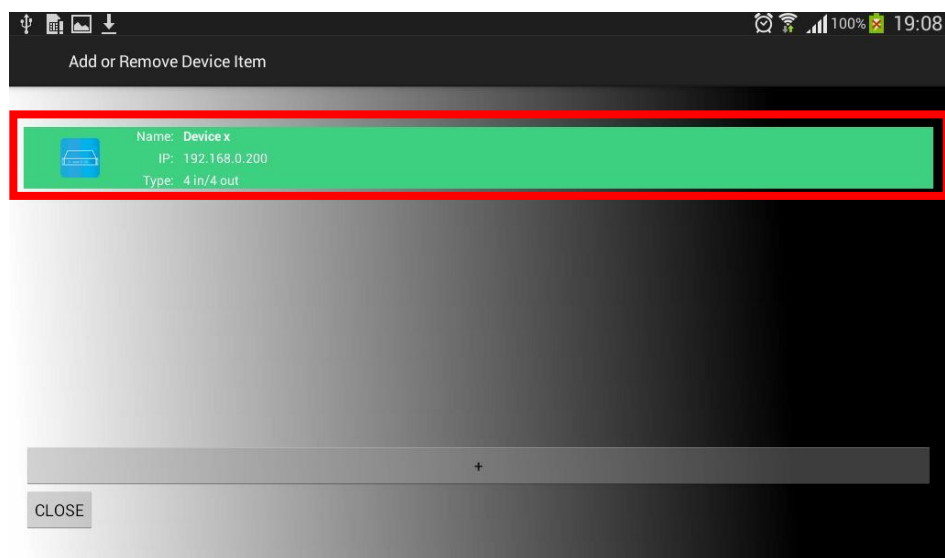

Drawing 1

- Press + to add column.
- Press middle column (red box) to enter and modify information page, press middle column as drawing 2

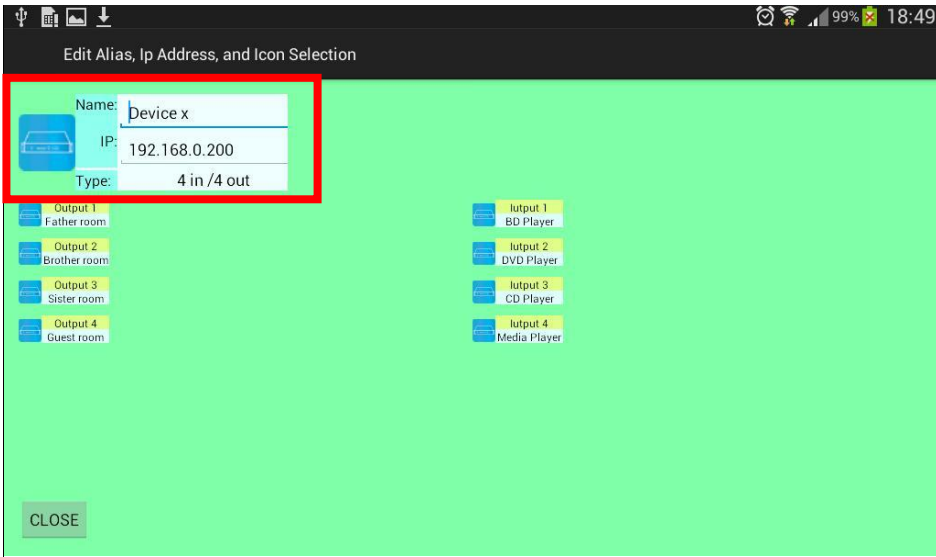

Drawing 2

- Change **Name** and **IP** , **IP** need to setup same as **MATRIX** host
- Enter **Output** and **Input** to change **Alias**, as drawing 3
- Enter drawing 3 Red box to change the icon as drawing 4
- Press **Close** to turn off the currently edit status

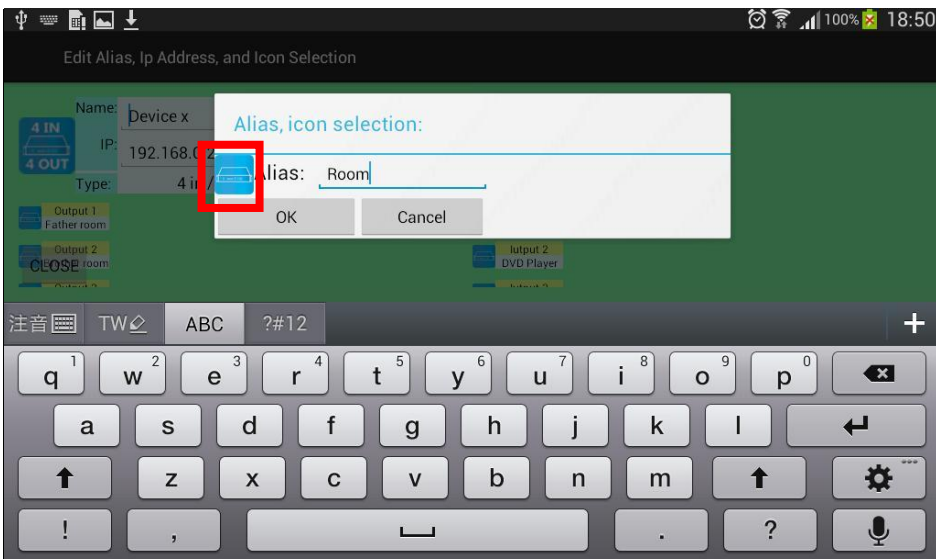

Drawing 3

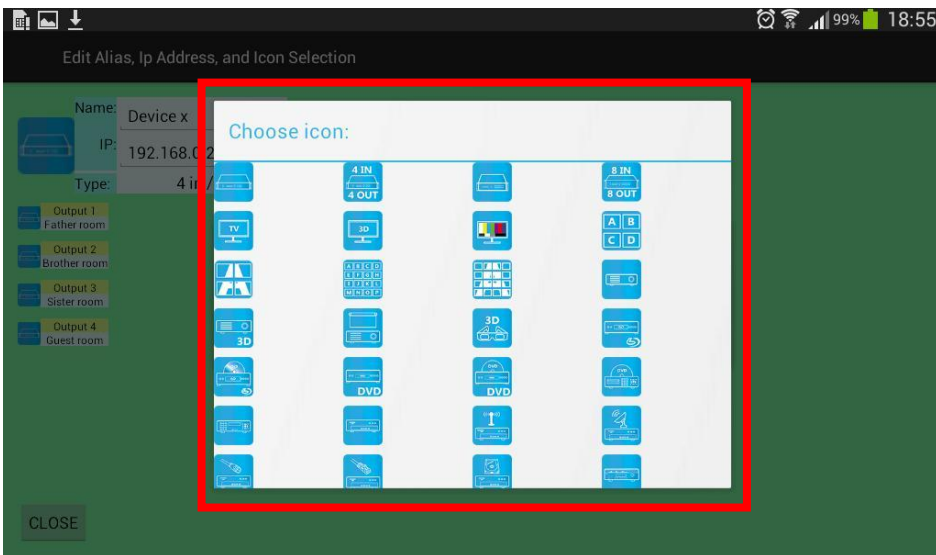

Drawing 4

Mobile Phone Control Input port Switch

Main Page:



- Middle column (Red box) is **MATRIX** information column, press middle column enter INPUT/OUTPUT control page.

Input Port Switch page:

Drawing 1:



- **POWER** : Switch **MATRIX** power on/standby

Drawing 2:

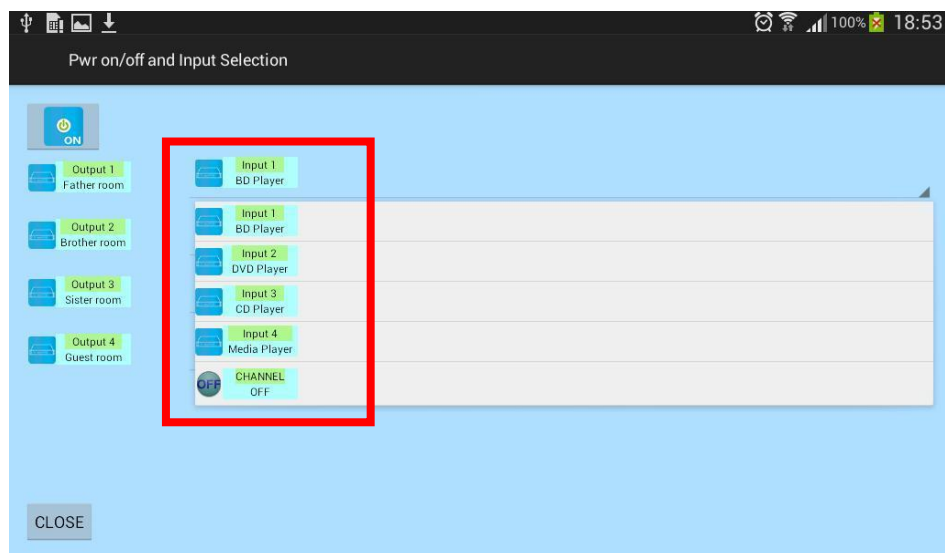

- **INPUT 1 ~ 4 are** selectable icons , enter any one **ICON** will pull out 4 inputs and **Off**.
- Press **Close** back to main page

ITEM NO	HS04M
HDMI Resolution	1080p @ 60Hz 12bit , 3D
Video Input Interface	HDMI Type A x 4
Video Output Interface	HDMI Type A x 4
RS-232 Input/Output Interface	DB9 x 1(CONSOLE)
IR Receive Angle	± 45 degree
IR Receive Distance	5M
Power Adapter	DC 12V 4.2A
Power Consumption	2A
Temperature	Operation: 0 to 55°C , Storage: -20 to 85°C , Humidity: up to 95%
Dimension mm	483 x 197 x 44
Weight g	2400

RoHS CE FC

Rev. A