



CPLUS-12FTX

4K UHD+ HDMI over Fiber Transmitter



Operation Manual

DISCLAIMERS

The information in this manual has been carefully checked and is believed to be accurate. Cypress Technology assumes no responsibility for any infringements of patents or other rights of third parties which may result from its use.

Cypress Technology assumes no responsibility for any inaccuracies that may be contained in this document. Cypress also makes no commitment to update or to keep current the information contained in this document.

Cypress Technology reserves the right to make improvements to this document and/or product at any time and without notice.

COPYRIGHT NOTICE

No part of this document may be reproduced, transmitted, transcribed, stored in a retrieval system, or any of its part translated into any language or computer file, in any form or by any means—electronic, mechanical, magnetic, optical, chemical, manual, or otherwise—without express written permission and consent from Cypress Technology.

© Copyright 2018 by Cypress Technology.

All Rights Reserved.

TRADEMARK ACKNOWLEDGMENTS

All products or service names mentioned in this document may be trademarks of the companies with which they are associated.





SAFETY PRECAUTIONS

Please read all instructions before attempting to unpack, install or operate this equipment and before connecting the power supply.

Please keep the following in mind as you unpack and install this equipment:

- Always follow basic safety precautions to reduce the risk of fire, electrical shock and injury to persons.
- To prevent fire or shock hazard, do not expose the unit to rain, moisture or install this product near water.
- Never spill liquid of any kind on or into this product.
- Never push an object of any kind into this product through any openings or empty slots in the unit, as you may damage parts inside the unit.
- Do not attach the power supply cabling to building surfaces.
- Use only the supplied power supply unit (PSU). Do not use the PSU if it is damaged.
- Do not allow anything to rest on the power cabling or allow any weight to be placed upon it or any person walk on it.
- To protect the unit from overheating, do not block any vents or openings in the unit housing that provide ventilation and allow for sufficient space for air to circulate around the unit.
- Please completely disconnect the power when the unit is not in use to avoid wasting electricity.

REVISION HISTORY

VERSION NO.	DATE	SUMMARY OF CHANGE
VS1	21/06/18	Final technical review



CONTENTS

1. Introduction	1
2. Applications	1
3. Package Contents	1
4. System Requirements	2
5. Features	2
6. Operation Controls and Functions	3
6.1 Front Panel	3
6.2 Rear Panel.....	3
6.3 WebGUI Control	4
6.4 RS-232 Control	11
6.5 Telnet Control	11
6.6 RS-232 and Telnet Commands	12
7. Connection Diagram	16
7.1 Configuration 1	16
7.2 Configuration 2.....	17
8. Specifications	18
8.1 Technical Specifications	18
8.2 Video Specifications	19
8.3 Cable Specifications	20
9. Acronyms	20





1. INTRODUCTION

This HDMI over Fiber Transmitter is designed to extend your 4K UHD HDMI signal using a single segment of multi-mode optical fiber cable. Using fiber optical cable provides many advantages over traditional copper-based extension methods, including immunity to RF and magnetic interference, thinner and lighter cables, and much longer extension distances (up to 300 meters per segment). Multiple fiber Transceiver units can be placed between the Transmitter and Receiver to greatly extend the total extension distance via cascading (up to 300 additional meters per Transceiver) if the extra distance or flexibility is desired.

The HDMI input and output of this unit supports resolutions up to 4K@60Hz (4:4:4, 8-bit), 10/12-bit HDR, 16-bit Deep Color up to 1080p@60Hz, HD audio formats and other features defined by the HDMI 2.0 specification. The HDMI and Fiber outputs of this unit are mirrored, however HDMI sources with bandwidth higher than 10.2Gbps are automatically chroma and/or bit-depth subsampled for transmission over the fiber output. Six pre-defined internal EDIDs, two external EDID selections and a User uploaded EDID are available for EDID management. The unit provides intuitive front panel controls as well as RS-232, Telnet and WebGUI control options.

2. APPLICATIONS

- Entertainment Rooms & Home Theaters
- Showrooms & Demo Rooms
- Lecture Hall Presentations
- Public Commercial Displays

3. PACKAGE CONTENTS

- 1×HDMI over Fiber Transmitter
- 1×5V/2.6A DC Power Adapter
- 1×3.5mm to 9-pin D-sub Adapter Cable
- 1×Shockproof Feet (Set of 4)
- 1×Operation Manual

4. SYSTEM REQUIREMENTS

- HDMI source equipment such as a media player, video game console or set-top box.
- HDMI receiving equipment such as an HDTV, monitor or audio amplifier.
- The use of "Premium High Speed HDMI" cables is highly recommended.
- Use of the optical fiber output requires a compatible fiber Receiver or Transceiver and appropriate paired LC multi-mode fiber in a crossover configuration.

5. FEATURES

- HDMI with 3D & 4K@60Hz with HDR support
- DVI 1.0 compliant with the use of an HDMI-DVI adaptor
- HDCP 2.2 and 1.x compliant
- 1 HDMI (18Gbps) input
- Mirrored HDMI (18Gbps) and fiber (10.2Gbps, LC pair, multimode) outputs
- Supports UHD resolutions up to 4K@60Hz (4:4:4, 8-bit)
- Supports 16-bit Deep Color up to 1080p@60Hz
- HDMI sources with bandwidth higher than 10.2Gbps are automatically chroma and/or bit-depth subsampled for transmission over the fiber output
- Supports pass-through of audio formats: LPCM 2.0/5.1/7.1, Bitstream, and HD Bitstream
- Comprehensive EDID management support including 6 pre-defined internal EDIDs, 2 external EDIDs, and 1 User uploaded EDID
- Compatible with the 3x2 HDMI and Fiber Matrix Transceiver (optional)
- Fiber transmission distances of up to 300 meters
- Supports control via front panel, WebGUI, Telnet, and RS-232

6. OPERATION CONTROLS AND FUNCTIONS

6.1 Front Panel

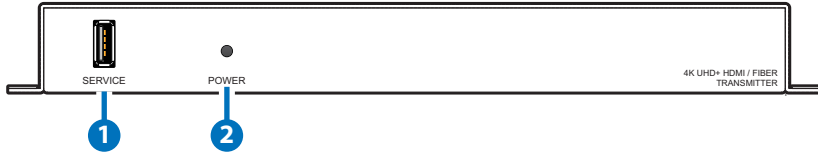

- 1 SERVICE:** This slot is reserved for firmware update use only.
- 2 POWER LED:** This LED will illuminate to indicate the unit is on and receiving power.

6.2 Rear Panel

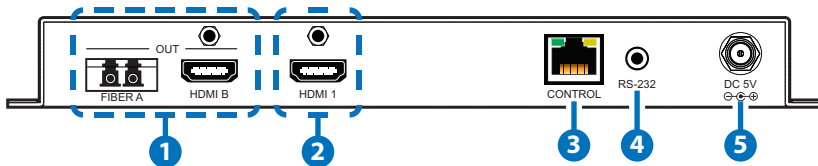

- 1 FIBER A & HDMI B OUT:** Connect the HDMI output to an HDMI TV, monitor or amplifier for digital video and audio output. Connect the fiber (paired LC) output to the fiber input on a compatible fiber Receiver or Transceiver unit.

Note: HDMI sources with bandwidth higher than 10.2Gbps are automatically chroma and/or bit-depth subsampled for transmission over the fiber output.

- 2 HDMI IN:** Connect to HDMI source equipment such as a media player, game console or set-top box. DVI sources are supported with the use of an HDMI to DVI adapter.
- 3 CONTROL:** Connect directly, or through a network switch, to your PC/laptop to control the unit via Telnet/WebGUI.
- 4 RS-232:** Connect, via the provided 9-pin adapter cable, to a PC, laptop or other serial control device to send RS-232 commands to control the unit.
- 5 DC 5V:** Plug the 5V DC power adapter into the unit and connect it to an AC wall outlet for power.

6.3 WebGUI Control

• Device Discovery APP

Please obtain the “Device Discovery” software from your authorized dealer and save it in a directory where you can easily find it.

Connect the unit and your PC/Laptop to the same active network and execute the “Device Discovery” software. Click on “Find Devices on Network” and a list of devices connected to the local network will show up indicating their current IP address.

Note: The unit's default IP address is 192.168.1.50.

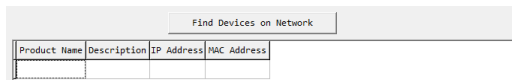

Product Name	Description	IP Address	MAC Address

By clicking on one of the listed devices you will be presented with the network details of that particular device.

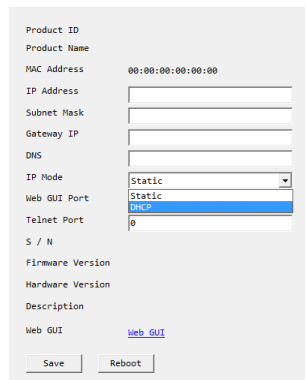

Product ID
 Product Name
 MAC Address 00:00:00:00:00:00
 IP Address
 Subnet Mask
 Gateway IP
 DNS
 IP Mode Static
 Web GUI Port Static
 Telnet Port 0
 S / N
 Firmware Version
 Hardware Version
 Description
 Web GUI [Web GUI](#)
 Save Reboot

- 1) IP Mode:** If you choose, you can alter the static IP network settings for the device, or switch the unit into DHCP mode to automatically obtain proper network settings from a local DHCP server. To switch to DHCP mode, please select DHCP from the IP mode drop-down, then click “Save” followed by “Reboot”.
- 2) WebGUI Hotkey:** Once you are satisfied with the network settings, you may use them to connect via Telnet or WebGUI. The network information window provides a convenient link to launch the WebGUI directly.



- **WebGUI Control Page**

After connecting to the WebGUI's address in a web browser, the login screen will appear. Please enter the appropriate user name and password then click "Submit" to log in.

Note: The default user name and password is "admin".

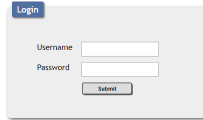

On the left side of the browser you will see the following menu tabs where all primary functions of the unit (Video, EDID Settings and System Settings) are controllable via the built in WebGUI. The individual functions will be introduced in the following sections.

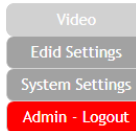

Clicking the red "Logout" tab will automatically log the currently connected user out of the WebGUI and return to login page.

• Video Tab

This tab provides control over the HDCP behavior of the HDMI input as well as the naming of the inputs and outputs.

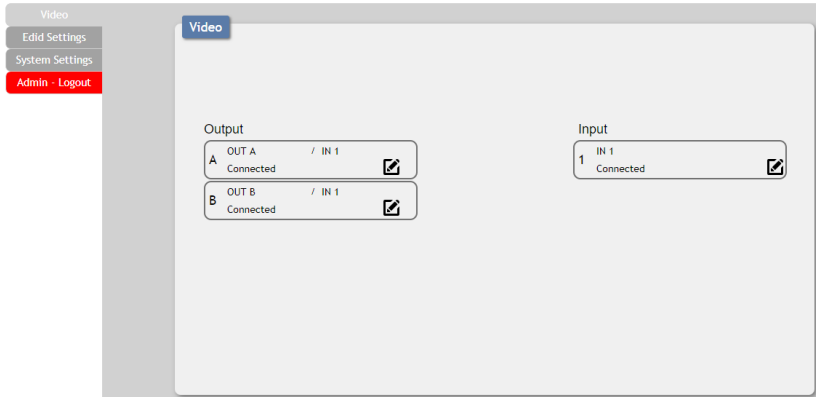

- 1) **Output:** Rename Output A or Output B by clicking on the appropriate edit icon to open the editing window then type in the preferred name for the output. Click on "Save" to confirm and activate any changes made to a name.
- 2) **Input:** Rename the Input or modify the HDCP behavior by clicking on the edit icon to open the editing window. Click on "Save" to confirm and activate any changes made to a name. Changes made to the HDCP behavior are applied immediately.
 - **Apple Mode:** Completely disables HDCP support on the input.
 - **Follow In:** HDCP support follows the HDCP mode required by the connected source device.
 - **Follow Out:** HDCP support follows the HDCP mode supported by the connected sinks.

• EDID Settings Tab

This tab provides control over the EDID behavior of the unit. There are six internal EDIDs, one customer uploaded EDID, and two sink sourced EDIDs that can be assigned to the HDMI input port. Both sink EDIDs and the Customer EDID are also available for download to the connected PC.

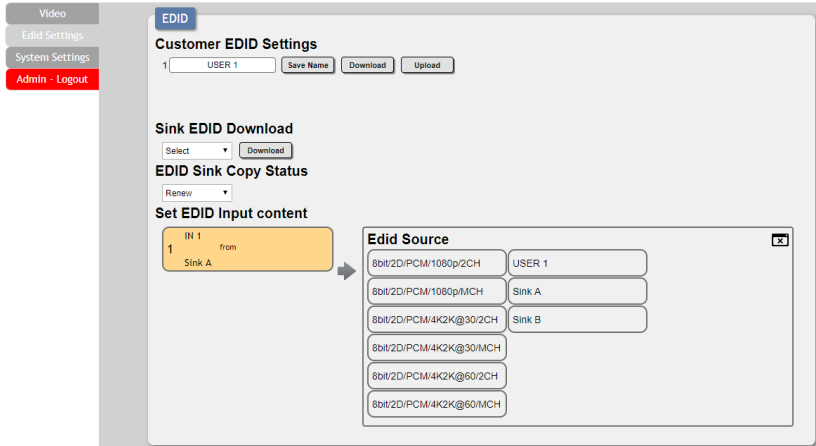

- 1) **Customer EDID Settings:** Manage the uploadable User EDID content.
 - **Save Name:** Type the preferred name for the User EDID in the space provided then click “Save Name” to confirm the change.
 - **Download:** Click to download and save the current User EDID as a file (*.bin) on the connected PC.
 - **Upload:** Click to upload a previously saved EDID file (*.bin) from the connected PC into the User EDID slot.
- 2) **Sink EDID Download:** Select and save the EDID from a connected display.
 - **Drop-down Menu:** Select the sink to read an EDID from for download.
 - **Download:** Click to download the EDID from the selected sink as a file (*.bin) to the connected PC.
- 3) **EDID Sink Copy Status:** This setting defines the EDID copy behavior when the EDID source is set to “SINK A” or “SINK B”.

- **Keep:** Will copy and use the selected sink's current EDID but will not re-copy the EDID if the sink is changed.
 - **Renew:** Will automatically copy and use the EDID from the selected sink every time a new sink is connected or the EDID changes.
- 4) **Set EDID Input Content:** This section provides a way to set the EDID to use with the HDMI input.
- **IN 1:** Click this button to select the HDMI Input and open the EDID Source table for assigning an EDID.
 - **EDID Source:** Click the EDID to assign to the HDMI Input. Once the EDID has been selected, the change will occur immediately.

The EDIDs available in the EDID Source table are:

EDID Source	EDID Content
8bit/2D/PCM/1080p/2CH	1080p@60Hz, LPCM 2.0
8bit/2D/PCM/1080p/MCH	1080p@60Hz, LPCM 7.1+Bitstream
8bit/2D/PCM/4K2K@30/2CH	4K@30Hz, LPCM 2.0
8bit/2D/PCM/4K2K@30/MCH	4K@30Hz, LPCM 7.1+Bitstream
8bit/2D/PCM/4K2K@60/2CH	4K@60Hz, LPCM 2.0
8bit/2D/PCM/4K2K@60/MCH	4K@60Hz, LPCM 7.1+Bitstream
USER 1	The currently uploaded Customer EDID
SINK A	EDID from the device on Output A
SINK B	EDID from the device on Output B

• System Settings Tab

This tab provides access to control a number of system configuration controls including displaying the unit's serial number, modifying the web access privileges, changing the IP configuration, performing a factory reset, rebooting the system, and updating the firmware.

- 1) **Serial Number:** Displays the unit's serial number.
- 2) **Web User Setting:** This section provides A way to change the password for the Administrator account. Click on “Save” to confirm and activate any changes made to these settings.

Note: The default password is “admin”.

- 3) **Network:** The IP Address, Netmask and Gateway can be set manually, or DHCP can be enabled for automatic IP Configuration if your local network supports it. Click on “Save” to confirm and activate any changes made to these settings.

Note: If the IP address is changed then the IP address required for WebGUI or Telnet access will also change accordingly.

4) System

- **Reboot:** Click this button to reboot the unit.
- **Factory Default:** Click this button to reset the unit to the factory default settings.

- 5) **Firmware Upgrade:** To update the unit's firmware, click the “Choose File” button to open the file selection window and then select

the firmware update file (*.bin format) located on your local PC. After selecting the file, click the "Upgrade" button to begin the firmware update process. Once the process completes the unit will automatically reboot.

6.4 RS-232 Control

Unit		Controlling PC		Serial Port Settings	
Pin	Definition	Pin	Definition		
1		1		Baud Rate	115200
2	TxD	2	RxD	Data Bits	8
3	RxD	3	TxD	Parity Bit	None
4		4		Stop Bits	1
5	GND	5	GND	Flow Control	None
6		6			
7		7			
8		8			
9		9			

6.5 Telnet Control

Before attempting to use Telnet control, please ensure that both the unit and the PC are connected to the same active networks.

To Access the Command Line Interface (CLI)	
Windows 7	Click Start , type "cmd" in the search field, and press Enter .
Windows XP	Click Start > Run , type "cmd", and press Enter .
Mac OS X	Click Go > Applications > Utilities > Terminal .

Once in the Command Line Interface (CLI) type "**telnet**" followed by the IP address of the unit (and the port number if it is non-standard) and then hit "Enter". This will connect us to the unit we wish to control. Type "**help**" to list the available commands. See below for reference.

```
Microsoft Windows [Version 6.1.7601]
Copyright (c) 2009 Microsoft Corporation. All rights reserved.
C:\Users\Administrator>telnet 192.168.1.50 23
```

Note: If the IP address is changed then the IP address required for Telnet access will also change accordingly.

6.6 RS-232 and Telnet Commands

COMMAND	
Description and Parameters	
HELP ↵	
	Show all available commands.
? ↵	
	Show all available commands.
SOURCEDET ↵	
	Show all source information.
SINKINFO ↵	
	Show all sink information.
HDCPIN 1 N1 ↵	
	Set the HDCP mode for the input.
	Available values for N1 :
1	[Follow In]
2	[Follow Out]
3	[Apple Mode]
EDIDIN 1 N1 ↵	
	Set the EDID to use on the input in "Appoint" mode.
	Available values for N1 :
1	[FHD/2CH]
2	[FHD/MCH]
3	[4K UHD/2CH]
4	[4K UHD/MCH]
5	[4K UHD+/2CH]
6	[4K UHD+/MCH]
7	[User EDID 1]
8	[SINK A]
9	[SINK B]

COMMAND	
Description and Parameters	
EDIDIN ?↵	
	Show the current EDID selection for the HDMI input.
INNAME 1 N1↵	
	Set the name of the input to name N1 .
N1 = {name}	[16 characters max]
INNAME ?↵	
	Show the current input name.
OUTNAME N1 N2↵	
	Set output N1 to name N2 .
N1 = A ~ B	[Output letter]
N2 = {Name}	[16 characters max]
OUTNAME ?↵	
	Show the current output names.
EDIDNAME 7 N1↵	
	Set the name of the User EDID to N1 .
N1 = {name}	[16 characters max]
EDIDNAME ?↵	
	Show the current user EDID name.
KEEPSINKEDID N1↵	
	Sets the EDID renewal behavior when "SINK A" or "SINK B" is selected as the EDID source.
	Available values for N1 :
0	[Renew]
1	[Keep]
IPCONFIG↵	
	Show the current IP configuration.

COMMAND	
Description and Parameters	
SETIP N1 N2 N3↵	
Set the static IP address, netmask, and gateway address for the unit with a single command. Disables DHCP.	
N1 = X.X.X.X	[X = 0 ~ 255, IP Address]
N2 = X.X.X.X	[X = 0 ~ 255, Netmask]
N3 = X.X.X.X	[X = 0 ~ 255, Gateway]
SIPADDR N1↵	
Set the static IP address. Disables DHCP.	
N1 = X.X.X.X	[X = 0 ~ 255]
SNETMASK N1↵	
Set the static Ethernet netmask. Disables DHCP.	
N1 = X.X.X.X	[X = 0 ~ 255]
SGATEWAY N1↵	
Set the static Ethernet gateway address. Disables DHCP.	
N1 = X.X.X.X	[X = 0 ~ 255]
RSTIP↵	
Reset the unit's Ethernet mode to use DHCP.	
ECHO N1↵	
Enable or disable echo when using the console connection.	
Available values for N1 :	
0	[Off]
1	[On]
ECHO ?↵	
Show the current console echo state.	
FADEFAULT↵	
Reset the unit to the factory defaults.	

COMMAND	
Description and Parameters	
VER↵	
	Show the unit's current firmware version.
REBOOT↵	
	Reboot the unit.
USBUPDATE↵	
	Put the unit into USB update mode.

Note: Commands will not be executed unless followed by a carriage return. Commands are not case-sensitive.

7. CONNECTION DIAGRAM

7.1 Configuration 1

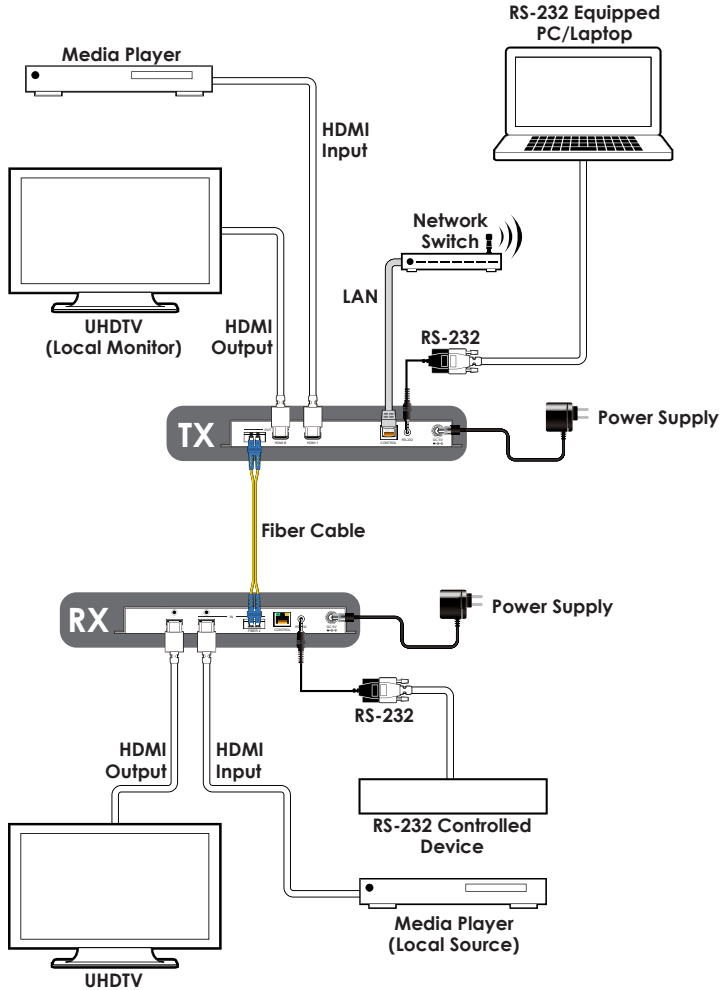

7.2 Configuration 2

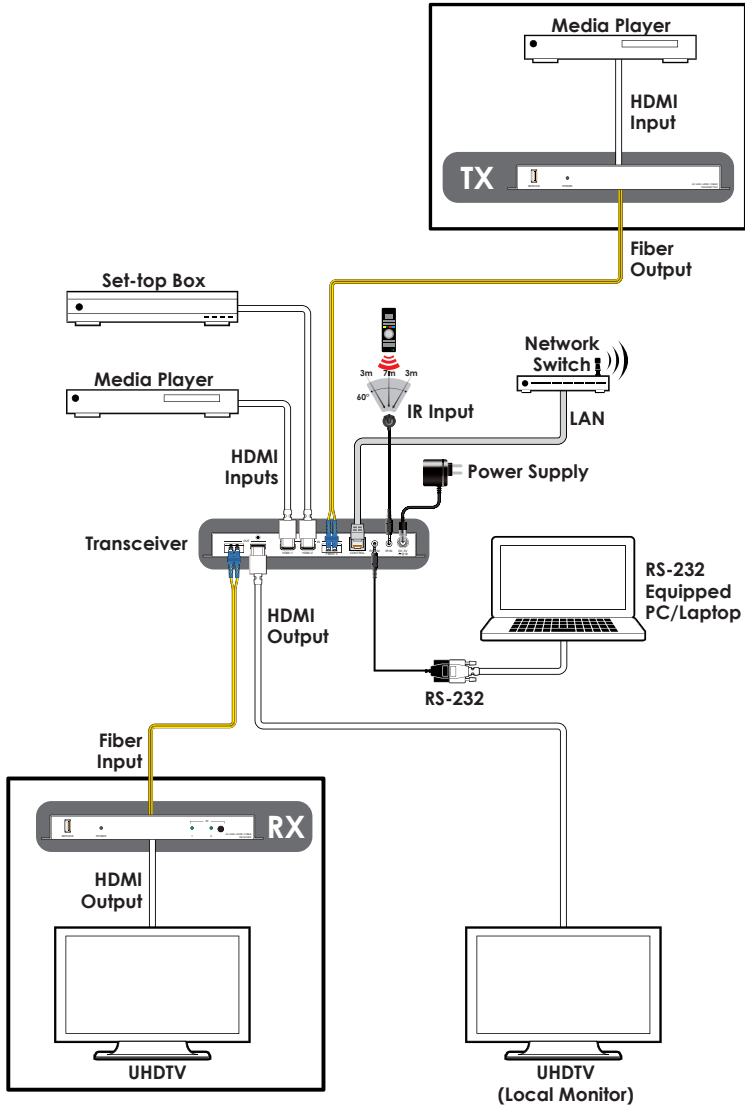

8. SPECIFICATIONS

8.1 Technical Specifications

HDMI Bandwidth	600MHz/18Gbps
Fiber Bandwidth	340MHz/10.2Gbps
Input Port	1×HDMI
Output Ports	1×HDMI 1×Fiber (Paired LC)
Control Ports	1×RS-232 (3.5mm) 1×IP Control (RJ45)
Baud Rate	Up to 115200bps
Power Supply	5V/2.6A DC (US/EU standards, CE/FCC/UL certified)
ESD Protection	Human Body Model: ±8kV (Air Discharge) ±4kV (Contact Discharge)
Dimensions	231.5mm×25mm×108mm (W×H×D) [Case Only] 231.5mm×25mm×117mm (W×H×D) [All Inclusive]
Weight	670g
Chassis Material	Metal
Silkscreen Color	Black
Operating Temperature	0 °C–40 °C/32 °F–104 °F
Storage Temperature	-20 °C–60 °C/-4 °F–140 °F
Relative Humidity	20–90% RH (Non-condensing)
Power Consumption	7.19W

8.2 Video Specifications

Supported Resolutions (Hz)	HDMI		Fiber
	Input	Output	Output
640×480@60/72/75/85	✓		x
720×480p@60	✓		x
720×576p@50	✓		x
800×600@56/60/72/75/85	✓		✓
1024×768@60/75/85	✓		✓
1280×720p@50/60	✓		✓
1280×768@60/70/75/85	✓		✓
1280×800@60	✓		✓
1280×1024@60	✓		✓
1360×768@60	✓		✓
1600×1200@60	✓		✓
1920×1080i@50/60	✓		✓
1920×1080p@24/25/30	✓		✓
1920×1080p@50/60	✓		✓
1920×1200@60 (RB)	✓		✓
3840×2160@24/25/30	✓		✓
3840×2160@50/60	✓		x
3840×2160@50 (YUV 4:2:0)	✓		✓
3840×2160@60 (YUV 4:2:0)	✓		✓
4096×2160@24/25/30	✓		✓
4096×2160@50/60	✓		x
4096×2160@50 (YUV 4:2:0)	✓		✓
4096×2160@60 (YUV 4:2:0)	✓		✓

8.3 Cable Specifications

HDMI Cable Length	1080p		4K
	8-bit	12-bit	8-bit
Input	10m	10m	3m
Output	10m	10m	3m

Fiber Cable Length	4K
Multi-mode OM3	300m

9. ACRONYMS

ACRONYM	COMPLETE TERM
CLI	Command-Line Interface
DVI	Digital Visual Interface
EDID	Extended Display Identification Data
GUI	Graphical User Interface
HD	High-Definition
HDCP	High-bandwidth Digital Content Protection
HDMI	High-Definition Multimedia Interface
HDR	High Dynamic Range
IP	Internet Protocol
LAN	Local Area Network
LPCM	Linear Pulse-Code Modulation
PC	Personal Computer
UHD	Ultra-High-Definition
UHDTV	Ultra-High-Definition Television
USB	Universal Serial Bus



CYPRESS TECHNOLOGY CO., LTD.

www.cypress.com.tw